

**Custom Cables**

Custom cable assemblies can be fabricated and certified to specification MIL-DTL-6117, or certified to your special specifications. McFarlane custom cables with standard fittings are pre stretched and proof loaded in accordance with MIL-DTL-5688. Cables using nonstandard fittings are proof loaded and pre stretched when possible, but cannot be certified to the MIL-DTL-5688 or MIL-DTL-6117 standards.

McFarlane can also manufacture and certify cable assemblies to the NAS302 through NAS310 standards. Cable assemblies requiring special non-standard terminals can be made quickly to your data or old cable using our precision machine shop, inspection system, and quality controlled processes. Several industry standard corrosion preventative coatings are also available. Our experienced engineering staff is available to develop cables for unique applications.

Traceability of all materials and test reports are maintained for our custom cables.

Our extensive stock of cable and fittings allows us to provide one to three day service for most orders. A custom cable design form is available at [www.mcfarlaneaviation.com](http://www.mcfarlaneaviation.com) or send us your old cable.

Custom assemblies are manufactured using the same materials and attention to quality as our FAA-PMA products, however, custom cables are not FAA-PMA approved.

**Stainless Steel or Galvanized Steel Cable?**

Stainless steel is corrosion resistant and works well in environments such as salt air, water saturation, or agricultural chemicals. Galvanized carbon steel and stainless cables are soaked in a MIL-SPEC rust preventative and lubricating compound. In normal environments the galvanized cable will not suffer from corrosion damage for decades.

The advantages of galvanized cable are its wear resistance and cost. Galvanized cable resists abrasion wear four or five times longer than stainless steel.

Stainless steel wire is high in nickel and therefore softer than the carbon steel wire. Stainless steel cable will show signs of wire wear at pulleys and fairleads much quicker than the galvanized carbon steel wire.

We recommend using galvanized steel cables except in coastal geographical areas, agricultural aircraft, float planes, and other applications where the cable is exposed directly to water. **Only McFarlane has FAA-PMA approved galvanized cables for the new production Cessna aircraft.**

All Beechcraft cables are made from galvanized steel cable and coated with a modified MIL-PRF-16173 compound. This is the same process used on Beechcraft original cables. It provides additional corrosion protection beyond the standard MIL-SPEC rust preventative oil. This provides both exceptional wear resistance and corrosion protection for many years.

**Bulk Cable**

McFarlane buys certified cable in large quantities direct from the mill. This allows us to provide low prices on bulk cable. McFarlane offers pre-packaged bulk cable in a variety of sizes. Cable can be ordered in 100 ft. or 500 ft. lengths. Certification from the cable manufacturer is given with every order.

**Pulleys**

McFarlane stocks all pulleys required for Cessna single engine aircraft. Our FAA-PMA approval on pulleys replace the AN, NAS and S series pulleys commonly used on the Cessna aircraft. Pulley kits are available that contain all the pulleys and cotter pins required for one aircraft. See the pulley section on pages 122-124 of the catalog for more details.

**Trim Control Chains**

McFarlane offers the trim control chains for Cessna single engine and most Beechcraft aircraft. Don't forget to replace your trim control chains and connecting links where necessary!

**Hardware**

McFarlane stocks an extensive inventory of cable hardware. We offer terminals, turnbuckles, eye ends, sleeves, locking clips, barrels and balls. Let our purchasing volume save you money!

**Buy Complete Kits and Save!**

McFarlane has complete flight control cable and trim chain kits for each of the different cable groups required to service most single engine aircraft from the Cessna model 120 through model 210 and cable kits for most Piper single engine airplanes. Most of the light aircraft fleet has seen many years of service and have endured many flight hours. Worn, rusty, and frayed cables are now common. It is a tedious, time consuming job to research the part manuals for all of the cables required for a complete aircraft. McFarlane has done the research and has all of the part numbers required for your aircraft.

We stock kits in either galvanized-carbon steel or stainless steel. All components are fully traceable and carry a one year limited warranty.

**Stock**

McFarlane has over 4,500 cable assemblies and chains in stock. We have FAA-PMA approved cables available in corrosion resistant stainless or high strength galvanized steel for most 100 and 200 series Cessna aircraft, PA28, PA32 and PA34 series Piper aircraft and G-164 series Ag-Cat aircraft. McFarlane also stocks cables for single engine piston and many turbine and twin engine Beechcraft, and stabilator adjust cables for Piper J-3, PA-11, PA-12, PA-14, PA-16, PA-18, PA-18A, PA-20 and PA-22.

**Quality**

McFarlane aircraft flight control cables offer quality that is second to none in the aircraft industry. Our quality assurance procedures and personnel are relentless, insuring that our aircraft flight control cables meet the highest standards possible. These standards exceed the military specifications that govern aircraft flight control cables.

Each McFarlane cable assembly is made from the highest quality U.S. manufactured materials from suppliers that have been listed by the U.S. government as being tested and qualified for government use (QPL listed). Before cable assemblies are accepted a sample from each lot of cable assemblies is subjected to a test load equal to 100% of their rated minimum breaking strength and then destroyed. Every cable terminal swaged on a cable assembly is inspected for proper dimension. All cable assemblies produced are pre-stretched to eliminate rigging and growth changes after installation. In addition each and every McFarlane cable assembly must endure a sustained proof load equal to 60% of the cable's minimum rated breaking strength assuring the safest and highest quality aircraft flight control cables available.

**We are one of a few DOD QML-6117 certified manufacturers of aircraft cable assemblies!**

- McFarlane quality is second to none!
- Over 25 years of cable experience!
- Cables available in galvanized and stainless steel
- Cables are sold in kits or separately
- When you order cable and cable terminals from McFarlane you will always receive a certified product!
- Our large volume purchases give you great prices!





# Flight Control System

## Flight Control Cables - Cessna



**120 1946-1947**  
S/N 8004 thru 12890  
Complete Cable Kit P/N CCKT120-01G (Galvanized)  
Complete Cable Kit P/N CCKT120-01S (Stainless Steel)  
Complete Pulley Kit P/N PULL-KT-01\*

Qty	P/N	Galv	SS	Location
1	MC0400107-5 or 105			Elevator Control Up
1	MC0400107-9 or 109			Elevator Control Down
1	MC0400107-6 <sup>2</sup>			Elevator Trim Carry Thru
1	MC0400107-7 or 7S			Elevator Trim Aft
1	MC0400107-8 or 8S			Elevator Trim Forward
2	MC0400107-4 or 104			Rudder Control
2	MC0400107-1 or 1CS			Aileron Direct
2	MC0400107-2 or 2CS			Aileron Carry Thru
2	MCS2295-25-63			Chain Elevator Trim
4	MCS2294-25			Chain Connecting Link

**120 1947** **1-1949**  
S/N 12891 thru 15075  
Complete Cable Kit P/N CCKT120-02G (Galvanized)  
Complete Cable Kit P/N CCKT120-02S (Stainless Steel)  
Complete Pulley Kit P/N PULL-KT-01\*

Qty	P/N	Galv	SS	Location
1	MC0400107-5 or 105			Elevator Control Up
1	MC0400107-9 or 109			Elevator Control Down
1	MC0400107-7 or 7S			Elevator Trim Aft
1	MC0400107-8 or 8S			Elevator Trim Forward
1	MC0400107-11 or 111			Elev Trim Carry Thru Forward
1	MC0400107-12 or 12S			Elev Trim Carry Thru Aft
2	MC0400107-4 or 104			Rudder Control
2	MC0400107-1 or 1CS			Aileron Direct
2	MC0400107-2 or 2CS			Aileron Carry Thru
2	MCS2295-25-63			Chain Elevator Trim
4	MCS2294-25			Chain Connecting Link

**140 1946**  
S/N 8004 thru 10069  
Complete Cable Kit P/N CCKT140-01G (Galvanized)  
Complete Cable Kit P/N CCKT140-01S (Stainless Steel)  
Complete Pulley Kit P/N PULL-KT-01\*

Qty	P/N	Galv	SS	Location
1	MC0400107-5 or 105			Elevator Control Up
1	MC0400107-9 or 109			Elevator Control Down
1	MC0400107-6 <sup>2</sup>			Elevator Trim Carry Thru
1	MC0400107-7 or 7S			Elevator Trim Aft
1	MC0400107-8 or 8S			Elevator Trim Forward
2	MC0400107-4 or 104			Rudder Control
2	MC0400107-1 or 1CS			Aileron Direct
1	MC0400107-2 or 2CS			Aileron Carry Thru
1	MC0400107-3 or 3			Flap Control
2	MCS2295-25-63			Chain Elevator Trim
4	MCS2294-25			Chain Connecting Link

**140 1947** **1-1949**  
S/N 10070 thru 12890  
Complete Cable Kit P/N CCKT140-02G (Galvanized)  
Complete Cable Kit P/N CCKT140-02S (Stainless Steel)  
Complete Pulley Kit P/N PULL-KT-01\*

Qty	P/N	Galv	SS	Location
1	MC0400107-5 or 105			Elevator Control Up
1	MC0400107-9 or 109			Elevator Control Down
1	MC0400107-6 <sup>2</sup>			Elevator Trim Carry Thru
1	MC0400107-7 or 7S			Elevator Trim Aft
1	MC0400107-8 or 8S			Elevator Trim Forward
2	MC0400107-4 or 104			Rudder Control
2	MC0400107-1 or 1CS			Aileron Direct
1	MC0400107-2 or 2CS			Aileron Carry Thru
1	MC0400107-10 or 10S			Flap Control
2	MCS2295-25-63			Chain Elevator Trim
4	MCS2294-25			Chain Connecting Link

**140 1947** **1-1949**  
S/N 12891 thru 15075  
Complete Cable Kit P/N CCKT140-03G (Galvanized)  
Complete Cable Kit P/N CCKT140-03S (Stainless Steel)  
Complete Pulley Kit P/N PULL-KT-01\*

Qty	P/N	Galv	SS	Location
1	MC0400107-5 or 105			Elevator Control Up
1	MC0400107-9 or 109			Elevator Control Down
1	MC0400107-11 or 111			Elevator Trim Carry Thru Fwd
1	MC0400107-12 or 12S			Elevator Trim Carry Thru Aft
1	MC0400107-7 or 7S			Elevator Trim Aft
1	MC0400107-8 or 8S			Elevator Trim Forward
2	MC0400107-4 or 104			Rudder Control
2	MC0400107-1 or 1CS			Aileron Direct
1	MC0400107-2 or 2CS			Aileron Carry Thru
1	MC0400107-10 or 10S			Flap Control
2	MCS2295-25-63			Chain Elevator Trim
4	MCS2294-25			Chain Connecting Link

**140A 1949-1951**  
S/N 15200 thru 15724  
Complete Cable Kit P/N CCKT140-04G (Galvanized)  
Complete Cable Kit P/N CCKT140-04S (Stainless Steel)  
Complete Pulley Kit P/N PULL-KT-02\*

Qty	P/N	Galv	SS	Location
1	MC0400107-5 or 105			Elevator Control Up
1	MC0400107-9 or 109			Elevator Control Down
1	MC0400107-11 or 111			Elevator Trim Carry Thru Fwd
1	MC0400107-12 or 12S			Elevator Trim Carry Thru Aft
1	MC0400107-13 or 113			Elevator Trim Aft

Continued from previous column

Qty	P/N	Galv	SS	Location
1	MC0400107-14 or 114			Elevator Trim Forward
1	MC0400107-18 or 118			Aileron Carry Thru
2	MC0400107-17 or 117			Aileron Direct
1	MC0400107-10 or 10S			Flap Control
2	MCS2295-25-63			Chain Elevator Trim
4	MCS2294-25			Chain Connecting Link

**150 1959**  
S/N 17001 thru 17438  
Complete Cable Kit P/N CCKT150-01G (Galvanized)  
Complete Cable Kit P/N CCKT150-01S (Stainless Steel)  
Complete Pulley Kit P/N PULL-KT-03\*

Qty	P/N	Galv	SS	Location
2	MC0400107-31 or 131			Aileron Direct
1	MC0400107-21 or 121			Aileron Carry Thru
2	MC0400107-4 or 104			Rudder Control
1	MC0400107-5 or 105			Elevator Up
1	MC0400107-9 or 109			Elevator Down
1	MC0400107-22 or 122			Flap Extend Forward
1	MC0400107-23 or 123			Flap Retract Forward
2	MC0400107-34 or 134			Flap Extend LH
2	MC0400107-26 or 126			Flap Retract
1	MC0400107-11 or 111			Trim Wheel to Disconnect
1	MC0400107-29 or 129			Trim Wheel to Turnbuckle
1	MC0400107-28 or 128			Trim Act to Disconnect
1	MC0400107-30 or 130			Trim Act to Turnbuckle
2	MCS2295P25-69			Elevator Trim Chain
4	MCS2294-25			Chain Connecting Link
4	MC0422280			Aileron Bellcrank Bushing

**150 1959**  
S/N 17439 thru 17558  
Complete Cable Kit P/N CCKT150-02G (Galvanized)  
Complete Cable Kit P/N CCKT150-02S (Stainless Steel)  
Complete Pulley Kit P/N PULL-KT-03\*

Qty	P/N	Galv	SS	Location
2	MC0400107-31 or 131			Aileron Direct
1	MC0400107-21 or 121			Aileron Carry Thru
2	MC0400107-4 or 104			Rudder Control
1	MC0400107-5 or 105			Elevator Up
1	MC0400107-9 or 109			Elevator Down
1	MC0400107-22 or 122			Flap Extend Forward
1	MC0400107-23 or 123			Flap Retract Forward
2	MC0400107-34 or 134			Flap Extend LH
1	MC0400107-26 or 126			Flap Retract
1	MC0400107-33 or 133			Flap Retract LH
1	MC0400107-11 or 111			Trim Wheel to Disconnect
1	MC0400107-29 or 129			Trim Wheel to Turnbuckle
1	MC0400107-28 or 128			Trim Act to Disconnect
1	MC0400107-30 or 130			Trim Act to Turnbuckle
2	MCS2295P25-69			Elevator Trim Chain
4	MCS2294-25			Chain Connecting Link
4	MC0422280			Aileron Bellcrank Bushing

**150 1959** **1-1960**  
S/N 17559 thru 59018  
Complete Cable Kit P/N CCKT150-03G (Galvanized)  
Complete Cable Kit P/N CCKT150-03S (Stainless Steel)  
Complete Pulley Kit P/N PULL-KT-03\*

Qty	P/N	Galv	SS	Location
2	MC0400107-31 or 131			Aileron Direct
1	MC0400107-21 or 121			Aileron Carry Thru
2	MC0400107-4 or 104			Rudder Control
1	MC0400107-5 or 105			Elevator Up
1	MC0400107-9 or 109			Elevator Down
1	MC0400107-22 or 122			Flap Extend Forward
1	MC0400107-23 or 123			Flap Retract Forward
2	MC0400107-34 or 134			Flap Extend LH
1	MC0400107-26 or 126			Flap Retract
1	MC0400107-33 or 133			Flap Retract LH
1	MC0400107-11 or 111			Trim Wheel to Disconnect
1	MC0400107-29 or 129			Trim Wheel to Turnbuckle
1	MC0400107-28 or 128			Trim Act to Disconnect
1	MC0400107-30 or 130			Trim Act to Turnbuckle
2	MCS2295P25-69			Elevator Trim Chain
4	MCS2294-25			Chain Connecting Link
4	MC0422280			Aileron Bellcrank Bushing

**150A,B,C 1961-1963**  
S/N 15059019 thru 15060087  
Complete Cable Kit P/N CCKT150-04G (Galvanized)  
Complete Cable Kit P/N CCKT150-04S (Stainless Steel)  
Complete Pulley Kit P/N PULL-KT-04\*

Qty	P/N	Galv	SS	Location
2	MC0400107-35 or 135			Aileron Direct
1	MC0400107-21 or 121			Aileron Carry Thru
2	MC0400107-4 or 104			Rudder Control
1	MC0400107-5 or 105			Elevator Up
1	MC0400107-9 or 109			Elevator Down
1	MC0400107-22 or 122			Flap Extend Forward
1	MC0400107-23 or 123			Flap Retract Forward
2	MC0400107-34 or 134			Flap Extend LH
2	MC0400107-33 or 133			Flap Retract LH
1	MC0400107-11 or 111			Trim Wheel to Disconnect
1	MC0400107-29 or 129			Trim Wheel to Turnbuckle
1	MC0400107-28 or 128			Trim Act to Disconnect
1	MC0400107-30 or 130			Trim Act to Turnbuckle
2	MCS2295P25-69			Elevator Trim Chain
4	MCS2294-25			Chain Connecting Link
4	MC0422280			Aileron Bellcrank Bushing

**150D,E 1964-1965**  
S/N 15060088 thru 15061532  
Complete Cable Kit P/N CCKT150-05G (Galvanized)  
Complete Cable Kit P/N CCKT150-05S (Stainless Steel)  
Complete Pulley Kit P/N PULL-KT-05\* or 06\* Note 1

Qty	P/N	Galv	SS	Location
2	MC0400107-41 or 141			Aileron Direct
1	MC0400107-21 or 121			Aileron Carry Thru
2	MC0400107-4 or 104			Rudder Control
1	MC0400107-5 or 105			Elevator Up
1	MC0400107-9 or 109			Elevator Down
2	MC0400107-39 or 139			Flap Extend Forward
2	MC0400107-37 or 137			Flap Retract Forward
2	MC0400107-40 or 140			Flap Extend to Bellcrank
2	MC0400107-38 or 138			Flap Retract to Bellcrank
1	MC0400107-11 or 111			Trim Wheel to Disconnect
1	MC0400107-29 or 129			Trim Wheel to Turnbuckle
1	MC0400107-28 or 128			Trim Act to Disconnect
1	MC0400107-30 or 130			Trim Act to Turnbuckle
2	MCS2295P25-69			Elevator Trim Chain
4	MCS2294-25			Chain Connecting Link
4	MC0422280			Aileron Bellcrank Bushing

Note 1: S/N 15060088 thru 15061083 USE PULL-KT-05  
S/N 15061084 thru 15061532 USE PULL-KT-06

Continued from previous column

Qty	P/N	Galv	SS	Location
4	MCS2294-25			Chain Connecting Link
4	MC0422280			Aileron Bellcrank Bushing

**150F 1966**  
S/N 15061533 thru 15061778  
Complete Cable Kit P/N CCKT150-06G (Galvanized)  
Complete Cable Kit P/N CCKT150-06S (Stainless Steel)  
Complete Pulley Kit P/N PULL-KT-07\*

Qty	P/N	Galv	SS	Location
2	MC0400107-41 or 141			Aileron Direct
1	MC0400107-21 or 121			Aileron Carry Thru
2	MC0400107-47 or 147			Rudder Control Forward
2	MC0400107-48 or 148			Rudder Control Aft
1	MC0400107-5 or 105			Elevator Up
1	MC0400107-9 or 109			Elevator Down
2	MC0400107-45 or 145			Flap
2	MC0400107-46 or 146			Flap
1	MC0400107-42 or 142			Trim Wheel to Disconnect
1	MC0400107-43 or 143			Trim Wheel to Turnbuckle
1	MC0400107-28 or 128			Trim Act to Disconnect
1	MC0400107-30 or 130			Trim Act to Turnbuckle
2	MCS2295P25-69			Elevator Trim Chain
4	MCS2294-25			Chain Connecting Link
4	MC0422280			Aileron Bellcrank Bushing

**150F 1966** **1-1967**  
S/N 15061779 thru 15067198  
S/N F1500001 thru F1500219  
Complete Cable Kit P/N CCKT150-11G (Galvanized)  
Complete Cable Kit P/N CCKT150-11S (Stainless Steel)  
Complete Pulley Kit P/N PULL-KT-07\* Note 1

Qty	P/N	Galv	SS	Location
2	MC0400107-41 or 141			Aileron Direct
1	MC0400107-21 or 121			Aileron Carry Thru
1	MC0400107-49 or 149 <sup>3</sup>			Rudder Control LH
1	MC0400107-50 or 150 <sup>3</sup>			Rudder Control RH
1	MC0400107-5 or 105			Elevator Up
1	MC0400107-9 or 109			Elevator Down
2	MC0400107-45 or 145			



Continued from previous page  
 1 MC0400107-30 or 130 Trim Actuator to Turnbuckle  
 1 MC0400107-52 or 152 Trim Wheel to Disconnect  
 1 MC0400107-53 or 153 Trim Wheel to Turnbuckle  
 1 MCS2295P25-69 Chain to Tab Actuator  
 1 MCS2295-25-61 Chain Trim Wheel  
 1 MCS2294-25 Chain Connecting Link  
 4 MC0422280 Aileron Bellcrank Bushing

Note 1: For S/N 15061779 thru 15069308 only  
**150J 1969F, F150J 1969**  
 S/N 15069309 thru 15070503, F1500390 thru F1500529  
 Complete Cable Kit P/N CCTK150-08G (Galvanized)  
 Complete Cable Kit P/N CCTK150-08S (Stainless Steel)  
 Complete Pulley Kit P/N PULL-KT-09\* Note 1

Qty P/N	Galv	SS	Location
2	MC0400107-41 or 141		Aileron Direct
1	MC0400107-21 or 121		Aileron Carry Thru
1	MC0400107-49 or 149		Rudder Control LH
1	MC0400107-50 or 150		Rudder Control RH
1	MC0400107-5 or 105		Elevator Up
1	MC0400107-9 or 109		Elevator Down
2	MC0400107-45 or 145		Flap
2	MC0400107-46 or 146		Flap
1	MC0400107-28 or 128		Trim Actuator to Disconnect
1	MC0400107-30 or 130		Trim Actuator to Turnbuckle
1	MC0400107-54 or 154		Trim Wheel to Disconnect
1	MC0400107-55 or 155		Trim Wheel to Turnbuckle
1	MCS2295P25-69		Chain Trim Actuator
1	MCS2295-25-61		Chain Trim Wheel
4	MCS2294-25		Chain Connecting Link
4	MC0422280		Aileron Bellcrank Bushing

Note 1: For S/N 15069309 thru 15070503 only

**150J K, L, M, A150K, L, M, F150M, L, M, FRA150L, M 1969 1975**  
 S/N 15070504 thru 15070055 Note 1,  
 A1500001 thru A1500609 Note 2,  
 F15000530 thru F15001248 Note 3,  
 FA1500001 thru FA1500120 Note 4,  
 FRA1500121 thru FRA1500281 Note 5  
 Complete Cable Kit P/N CCTK150-09G (Galvanized)  
 Complete Cable Kit P/N CCTK150-09S (Stainless Steel)  
 Complete Pulley Kit P/N PULL-KT-09\* thru PULL-KT-12\*

Qty P/N	Galv	SS	Location
2	MC0400107-41 or 141		Aileron Direct
1	MC0400107-21 or 121		Aileron Carry Thru
1	MC0400107-49 or 149		Rudder Control LH
1	MC0400107-50 or 150		Rudder Control RH
1	MC0400107-5 or 105		Elevator Up
1	MC0400107-9 or 109		Elevator Down
2	MC0400107-45 or 145		Flap
2	MC0400107-46 or 146		Flap
1	MC0400107-28 or 128		Trim Actuator to Disconnect
1	MC0400107-30 or 130		Trim Actuator to Turnbuckle
1	MC0400107-55 or 155		Trim Wheel to Turnbuckle
1	MC0400107-56 or 156		Trim Wheel to Disconnect
1	MCS2295P25-69		Chain Trim Actuator
1	MCS2295P25-63		Chain Trim Wheel
4	MCS2294-25		Chain Connecting Link
4	MC0422280		Aileron Bellcrank Bushing

Note 1: S/N 15070504 thru 15071128 USE PULL-KT-09  
 S/N 15071129 thru 15074399 USE PULL-KT-10  
 S/N 15074400 thru 15074661 USE PULL-KT-11  
 S/N 15074662 thru 15077005 USE PULL-KT-12  
 Note 2: S/N A1500001 thru A1500387 USE PULL-KT-10  
 S/N A1500388 thru A1500415 USE PULL-KT-11  
 Note 3: S/N F15000530 thru F15000943 USE PULL-KT-10  
 S/N F1500944 thru F15001062 USE PULL-KT-11  
 S/N F15001063 thru F15001248 USE PULL-KT-12  
 Note 4: S/N FA1500001 thru FA1500120 USE PULL-KT-10  
 Note 5: S/N FRA1500121 thru FRA1500211 USE PULL-KT-10  
 S/N FRA1500212 thru FRA1500261 USE PULL-KT-12

**150M 1, A150M 1, F150M 1, FRA150M 1 1976-1977**  
 S/N 15077006 thru 15079405,  
 A1500610 thru A1500734,  
 F15001249 thru F15001428,  
 FRA1500282 thru FRA1500336  
 Complete Cable Kit P/N CCTK150-10G (Galvanized)  
 Complete Cable Kit P/N CCTK150-10S (Stainless Steel)  
 Complete Pulley Kit P/N PULL-KT-12\* Note 1

Qty P/N	Galv	SS	Location
2	MC0400107-41 or 141		Aileron Direct
1	MC0400107-21 or 121		Aileron Carry Thru
1	MC0400107-49 or 149		Rudder Control LH
1	MC0400107-50 or 150		Rudder Control RH
1	MC0400107-5 or 105		Elevator Up
1	MC0400107-9 or 109		Elevator Down
2	MC0400107-45 or 145		Flap
2	MC0400107-46 or 146		Flap
1	MC0400107-57 or 157		Trim Actuator to Disconnect
1	MC0400107-30 or 130		Trim Actuator to Turnbuckle
1	MC0400107-55 or 155		Trim Wheel to Turnbuckle
1	MC0400107-56 or 156		Trim Wheel to Disconnect
1	MCS2295P25-69		Chain Trim Actuator
1	MCS2295P25-63		Chain Trim Wheel
4	MCS2294-25		Chain Connecting Link
4	MC0422280		Aileron Bellcrank Bushing

Note 1: PULL-KT-12 is eligible for all serial numbers except S/N A1500610 thru A1500734

**152 1, A152 1, F152 1, FA152 1 1978 1-1979 1**  
 S/N 15279406 thru 15281298,  
 15281300 thru 15281314, 15281316 thru 15281326,  
 15281328 thru 15281340, 15281342 thru 15281349,  
 15281351 thru 15281359, 15281361 thru 15281369,  
 15281371 thru 15281380, 15281382 thru 15281389,  
 15281391 thru 15281400, 15281402 thru 15281409,  
 15281411 thru 15281420, 15281422 thru 15281426,  
 A1520735 thru A1520785, F15201429 thru F15201538,  
 FA1520337 thru FA1520352  
 Complete Cable Kit P/N CCTK152-01G (Galvanized)  
 Complete Cable Kit P/N CCTK152-01S (Stainless Steel)  
 Complete Pulley Kit P/N PULL-KT-13\*

Qty P/N	Galv	SS	Location
1	MC0400107-5 or 105		Elevator Up
1	MC0400107-9 or 109		Elevator Down
1	MC0400107-56 or 156		Trim Wheel to Disconnect
1	MC0400107-55 or 155		Trim Wheel to Turnbuckle
1	MC0400107-30 or 130		Trim Actuator to Turnbuckle
1	MC0400107-57 or 157		Trim Actuator to Disconnect
1	MC0400107-49 or 149		Rudder Control LH
1	MC0400107-50 or 150		Rudder Control RH
2	MC0400107-45 or 145		Flap
2	MC0400107-46 or 146		Flap
2	MC0400107-41 or 141		Aileron Direct
1	MC0400107-21 or 121		Aileron Carry Thru
1	MCS2295P25-63		Chain Trim Wheel
1	MCS2295P25-69		Chain Trim Actuator
4	MCS2294-25		Chain Connecting Link
4	MC0422280		Aileron Bellcrank Bushing

**152 1, A152 1, F152 1, FA152 1 1978 1-1985**  
 S/N 15281299, 15281315, 15281327, 15281341, 15281350,  
 15281360, 15281370, 15281381, 15281390, 15281401,  
 15281410, 15281421,  
 15281427 thru 15286033, A1520786 thru A1521049,  
 F15201539 thru F15201980,  
 FA1520353 thru FA1520425  
 Complete Cable Kit P/N CCTK152-02G (Galvanized)  
 Complete Cable Kit P/N CCTK152-02S (Stainless Steel)  
 Complete Pulley Kit P/N PULL-KT-13\* Note 1

Qty P/N	Galv	SS	Location
2	MC0400107-66 or 166		Elevator Forward
1	MC0400107-63 or 163		Elevator Up Aft
1	MC0400107-64 or 164		Elevator Down Aft
1	MC0400107-56 or 156		Trim Wheel to Disconnect
1	MC0400107-55 or 155		Trim Wheel to Turnbuckle
1	MC0400107-30 or 130		Trim Actuator to Turnbuckle
1	MC0400107-57 or 157		Tab Actuator to Disconnect
1	MC0400107-49 or 149		Rudder Control LH
1	MC0400107-50 or 150		Rudder Control RH
2	MC0400107-45 or 145		Flap
2	MC0400107-46 or 146		Flap
2	MC0400107-60 or 160		Aileron Direct Cabin
1	MC0400107-61 or 161		Aileron Direct LH Wing
1	MC0400107-65 or 165		Aileron Direct RH Wing
1	MC0400107-59 or 159		Aileron Carry Thru LH
1	MC0400107-58 or 158		Aileron Carry Thru RH
1	MCS2295P25-63		Chain Trim Wheel
1	MCS2295P25-69		Chain Trim Actuator
4	MCS2294-25		Chain Connecting Link
4	MC0422280		Aileron Bellcrank Bushing

Note 1: PULL-KT-13 is eligible for all serial numbers except as noted below.  
 For S/N F15201539 thru F15201952 only  
 For S/N FA1520353 thru FA1520387 only

**170 1948**  
 S/N 18000 thru 18729  
 Complete Cable Kit P/N CCTK170-01G (Galvanized)  
 Complete Cable Kit P/N CCTK170-01S (Stainless Steel)  
 Complete Pulley Kit P/N PULL-KT-14\*

Qty P/N	Galv	SS	Location
2	MC0510105-2 or 102		Aileron Direct
2	MC0510105-3 or 103		Aileron Carry Thru
2	MC0510105-6 or 106		Flap Control Upper
1	MC0510105-5 or 105		Flap Control Lower
2	MC0510105-1 or 101		Rudder Control
2	MC0510105-4 or 104		Elevator Control
1	MC0510105-9 or 109		Trim Wheel to Turnbuckle
1	MC0510105-7 or 107		Trim Wheel to Disconnect
1	MC0510105-8 or 108		Trim Actuator to Turnbuckle
1	MC0510105-10 or 110		Trim Actuator to Disconnect
2	MCS2295-25-63		Chain Elevator Trim
4	MCS2294-25		Chain Connecting Link

**170A 1949-1951**  
 S/N 18730 thru 20266  
 Complete Cable Kit P/N CCTK170-02G (Galvanized)  
 Complete Cable Kit P/N CCTK170-02S (Stainless Steel)  
 Complete Cable Kit P/N CCTK170-02SF (Float Plane)  
 Complete Pulley Kit P/N PULL-KT-15\*

Qty P/N	Galv	SS	Location
2	MC0510105-12 or 112		Aileron Direct
1	MC0510105-13 or 113		Aileron Carry Thru
2	MC0510105-11 or 111		Flap Control Upper
1	MC0510105-5 or 105		Flap Control Lower
1	MC0510105-114		Flap Control Lower
2	MC0510105-1 or 101		Rudder Control
1	MC0510105-15 or 115		Elevator Control Upper

Kit continues in next column

Continued from previous column  
 Qty P/N Galv SS Location  
 1 MC0510105-4 or 104 Elevator Control Lower  
 1 MC0510105-9 or 109 Trim Wheel to Turnbuckle  
 1 MC0510105-7 or 107 Trim Wheel to Disconnect  
 1 MC0510105-8 or 108 Trim Actuator to Turnbuckle  
 1 MC0510105-10 or 110 Trim Actuator to Disconnect  
 2 MCS2295-25-63 Chain Elevator Trim  
 4 MCS2294-25 Chain Connecting Link

**170B 1952-1954**  
 S/N 20267 thru 26504  
 Complete Cable Kit P/N CCTK170-03G (Galvanized)  
 Complete Cable Kit P/N CCTK170-03S (Stainless Steel)  
 Complete Pulley Kit P/N PULL-KT-16\*

Qty P/N	Galv	SS	Location
2	MC0510105-16 or 116		Aileron Direct
1	MC0510105-13 or 113		Aileron Carry Thru
1	MC0510105-21 or 121		Flap Return Forward
1	MC0510105-22 or 122		Flap Direct Forward
2	MC0510105-59 or 159		Flap Direct Outboard
1	MC0510105-61 or 161		Flap Direct LH Inboard
1	MC0510105-62 or 162		Flap Direct RH Inboard
2	MC0510105-60 or 160		Flap Return Outboard
1	MC0510105-63 or 163		Flap Return LH Inboard
1	MC0510105-64 or 164		Flap Return RH Inboard
2	MC0510105-1 or 101		Rudder Control
1	MC0510105-15 or 115		Elevator Control Upper
1	MC0510105-4 or 104		Elevator Control Lower
1	MC0510105-9 or 109		Trim Wheel to Turnbuckle
1	MC0510105-7 or 107		Trim Wheel to Disconnect
1	MC0510105-8 or 108		Trim Actuator to Turnbuckle
1	MC0510105-10 or 110		Trim Actuator to Disconnect
2	MCS2295-25-63		Chain Elevator Trim
4	MCS2294-25		Chain Connecting Link

**170B 1955-1956**  
 S/N 26505 thru 27169  
 Complete Cable Kit P/N CCTK170-04G (Galvanized)  
 Complete Cable Kit P/N CCTK170-04S (Stainless Steel)  
 Complete Pulley Kit P/N PULL-KT-16\*

Qty P/N	Galv	SS	Location
2	MC0510105-16 or 116		Aileron Direct
1	MC0510105-13 or 113		Aileron Carry Thru
1	MC0510105-21 or 121		Flap Return Forward
1	MC0510105-22 or 122		Flap Direct Forward
2	MC0510105-59 or 159		Flap Direct Outboard
1	MC0510105-61 or 161		Flap Direct LH Inboard
1	MC0510105-62 or 162		Flap Direct RH Inboard
2	MC0510105-60 or 160		Flap Return Outboard
1	MC0510105-63 or 163		Flap Return LH Inboard
1	MC0510105-64 or 164		Flap Return RH Inboard
2	MC0510105-1 or 101		Rudder Control
2	MC0510105-38 or 138		Tailwheel Steering
1	MC0510105-15 or 115		Elevator Control Upper
1	MC0510105-4 or 104		Elevator Control Lower
1	MC0510105-9 or 109		Trim Wheel to Turnbuckle
1	MC0510105-7 or 107		Trim Wheel to Disconnect
1	MC0510105-8 or 108		Trim Act to Turnbuckle
1	MC0510105-10 or 110		Trim Act to Disconnect
2	MCS2295-25-63		Chain Elevator Trim
4	MCS2294-25		Chain Connecting Link

**172 1956-1958**  
 S/N 28000 thru 36965  
 Complete Cable Kit P/N CCTK172175-01G (Galvanized)  
 Complete Cable Kit P/N CCTK172175-01S (Stainless Steel)  
 Complete Pulley Kit P/N PULL-KT-17\*

Qty P/N	Galv	SS	Location
2	MC0510105-39 or 139		Rudder Forward
1	MC0510105-56 or 156		Rudder Aft LH
1	MC0510105-55 or 155		Rudder Aft RH
1	MC0510105-42 or 142		Elevator Forward Upper
1	MC0510105-40 or 140		Elevator Forward Lower
1	MC0510105-41 or 141		Elevator Aft Upper
1	MC0510105-54 or 154		Elevator Aft Lower
1	MC0510105-58 or 158		Trim Wheel to Turnbuckle
1	MC0510105-57 or 157		Trim Wheel to Disconnect
1	MC0510105-44 or 144		Trim Act to Turnbuckle
1	MC0510105-45 or 145		Trim Act to Disconnect
2	MC0510105-16 or 116		Aileron Direct
1	MC0510105-13 or 113		Aileron Carry Thru
2	MC0510105-59 or 159		Flap Direct Upper
2	MC0510105-60 or 160		Flap Return Upper
1	MC0510105-63 or 163		Flap Return LH Lower
1	MC0510105-64 or 164		Flap Return RH Lower
1	MC0510105-61 or 161		Flap Direct LH Lower
1	MC0510105-62 or 162		Flap Direct RH Lower
1	MC0510105-21 or 121		Flap Return Forward
1	MC0510105-22 or 122		Flap Direct Forward
1	MCS2295-25-71		Chain Trim Wheel

Kit continues on next page

\* See pages 122-124 for Pulley Kit Components  
 1 Partial model eligibility  
 2 See note on the bottom of page 93 regarding rudder cable P/Ns MC0400107-49/149 and MC0400107-50/150 installation.  
 4 Not included in CCTK170-02SF  
 5 Only included in CCTK170-02SF

Flight Control System

# Flight Control System

## Flight Control Cables - Cessna

**Continued from previous page**

Qty	P/N	Galv	SS	Location
1	MCS2295-25-67			Chain Trim Actuator
4	MCS2294-25			Chain Connecting Link
4	MC0422280			Aileron Bellcrank Bushing

**1721 1959, 175 1958-1959**  
S/N 36966 thru 46754, 55001 thru 56238  
Complete Cable Kit P/N CCTK172175-02G (Galvanized)  
Complete Cable Kit P/N CCTK172175-02S (Stainless)  
Complete Pulley Kit P/N PULL-KT-17\*

Qty	P/N	Galv	SS	Location
2	MC0510105-39			Rudder Forward
1	MC0510105-56			Rudder Aft LH
1	MC0510105-55			Rudder Aft RH
1	MC0510105-42			Elevator Forward Upper
1	MC0510105-40			Elevator Forward Lower
1	MC0510105-41			Elevator Aft Upper
1	MC0510105-54			Elevator Aft Lower
1	MC0510105-58			Trim Wheel to Turnbuckle
1	MC0510105-57			Trim Wheel to Disconnect
1	MC0510105-44			Trim Actuator to Turnbuckle
1	MC0510105-45			Trim Actuator to Disconnect
2	MC0510105-72			Aileron Direct
1	MC0510105-13			Aileron Carry Thru
2	MC0510105-59			Flap Direct Upper
2	MC0510105-60			Flap Return Upper
1	MC0510105-63			Flap Return LH Lower
1	MC0510105-64			Flap Return RH Lower
1	MC0510105-61			Flap Direct LH Lower
1	MC0510105-62			Flap Direct RH Lower
1	MC0510105-21			Flap Return Forward
1	MC0510105-22			Flap Direct Forward
1	MCS2295-25-71			Chain Trim Wheel
1	MCS2295-25-67			Chain Trim Actuator
4	MCS2294-25			Chain Connecting Link
4	MC0422280			Aileron Bellcrank Bushing

**172A 1, 1960 1**  
S/N 46755 thru 47298  
Complete Cable Kit P/N CCTK172175-03G (Galvanized)  
Complete Cable Kit P/N CCTK172175-03S (Stainless)  
Complete Pulley Kit P/N PULL-KT-17\*

Qty	P/N	Galv	SS	Location
2	MC0510105-39			Rudder Forward
1	MC0510105-75			Rudder Aft LH
1	MC0510105-76			Rudder Aft RH
1	MC0510105-42			Elevator Forward Upper
1	MC0510105-40			Elevator Forward Lower
1	MC0510105-41			Elevator Aft Upper
1	MC0510105-54			Elevator Aft Lower
1	MC0510105-58			Trim Wheel to Turnbuckle
1	MC0510105-57			Trim Wheel to Disconnect
1	MC0510105-44			Trim Actuator to Turnbuckle
1	MC0510105-45			Trim Actuator to Disconnect
2	MC0510105-72			Aileron Direct
1	MC0510105-13			Aileron Carry Thru
2	MC0510105-59			Flap Direct Upper
2	MC0510105-60			Flap Return Upper
1	MC0510105-63			Flap Return LH Lower
1	MC0510105-64			Flap Return RH Lower
1	MC0510105-61			Flap Direct LH Lower
1	MC0510105-62			Flap Direct RH Lower
1	MC0510105-21			Flap Return Forward
1	MC0510105-22			Flap Direct Forward
1	MCS2295-25-71			Chain Trim Wheel
1	MCS2295-25-67			Chain Trim Actuator
4	MCS2294-25			Chain Connecting Link
4	MC0422280			Aileron Bellcrank Bushing

**172A 1, B, C 1960 1 - 1962 1, 5A, B, C 1960 - 1962 1**  
S/N 47299 thru 17249544, 56239 thru 17557119  
Complete Cable Kit P/N CCTK172175-04G (Galvanized)  
Complete Cable Kit P/N CCTK172175-04S (Stainless)  
Complete Pulley Kit P/N PULL-KT-17\*

Qty	P/N	Galv	SS	Location
2	MC0510105-39			Rudder Forward
1	MC0510105-80			Rudder Aft LH
1	MC0510105-81			Rudder Aft RH
1	MC0510105-42			Elevator Forward Upper
1	MC0510105-40			Elevator Forward Lower
1	MC0510105-41			Elevator Aft Upper
1	MC0510105-54			Elevator Aft Lower
1	MC0510105-58			Trim Wheel to Turnbuckle
1	MC0510105-57			Trim Wheel to Disconnect
1	MC0510105-44			Trim Actuator to Turnbuckle
1	MC0510105-45			Trim Actuator to Disconnect
2	MC0510105-72			Aileron Direct
1	MC0510105-13			Aileron Carry Thru
2	MC0510105-59			Flap Direct Upper
2	MC0510105-60			Flap Return Upper
1	MC0510105-63			Flap Return LH Lower
1	MC0510105-64			Flap Return RH Lower
1	MC0510105-61			Flap Direct LH Lower
1	MC0510105-62			Flap Direct RH Lower
1	MC0510105-21			Flap Return Forward
1	MC0510105-22			Flap Direct Forward
1	MCS2295-25-71			Chain Trim Wheel

Kit continues in next column

**Continued from previous column**

Qty	P/N	Galv	SS	Location
1	MC0510105-62			Flap Direct RH Lower
1	MCS2295-25-67			Chain Trim Actuator
4	MCS2294-25			Chain Connecting Link
4	MC0422280			Aileron Bellcrank Bushing

**172D, P172, F172D, FP172 1963**  
S/N 17249545 thru 17250572, P17257120 thru P17257188, F172-0001 thru F172-0018, FP172-0001 thru FP172-0003  
Complete Cable Kit P/N CCTK172175-05G (Galvanized)  
Complete Cable Kit P/N CCTK172175-05S (Stainless)  
Complete Pulley Kit P/N PULL-KT-18\*

Qty	P/N	Galv	SS	Location
1	MC0510105-205			Rudder Forward LH
1	MC0510105-206			Rudder Forward RH
2	MC0510105-207			Rudder Aft
2	MC0510105-208			Elevator Forward
1	MC0510105-290			Elevator Aft Lower
1	MC0510105-291			Elevator Aft Upper
1	MC0510105-58			Trim Wheel to Turnbuckle
1	MC0510105-57			Trim Wheel to Disconnect
1	MC0510105-44			Trim Actuator to Turnbuckle
1	MC0510105-45			Trim Actuator to Disconnect
2	MC0510105-72			Aileron Direct
1	MC0510105-13			Aileron Carry Thru
2	MC0510105-59			Flap Direct Upper
2	MC0510105-60			Flap Return Upper
1	MC0510105-63			Flap Return LH Lower
1	MC0510105-64			Flap Return RH Lower
1	MC0510105-61			Flap Direct LH Lower
1	MC0510105-62			Flap Direct RH Lower
1	MC0510105-21			Flap Return Forward
1	MC0510105-22			Flap Direct Forward
1	MC0510105-70			Parking Brake
1	MC0713070-28 2			Cable Assembly Park Brake
1	MCS2295-25-71			Chain Trim Wheel
1	MCS2295-25-67			Chain Trim Actuator
4	MCS2294-25			Chain Connecting Link
4	MC0422280			Aileron Bellcrank Bushing

**172E 1964**  
S/N 17250573 thru 17251822  
Complete Cable Kit P/N CCTK172175-06G (Galvanized)  
Complete Cable Kit P/N CCTK172175-06S (Stainless)  
Complete Pulley Kit P/N PULL-KT-19\*

Qty	P/N	Galv	SS	Location
1	MC0510105-205			Rudder Forward LH
1	MC0510105-206			Rudder Forward RH
2	MC0510105-207			Rudder Aft
2	MC0510105-208			Elevator Forward
1	MC0510105-290			Elevator Aft Lower
1	MC0510105-291			Elevator Aft Upper
1	MC0510105-213			Aileron Yoke Primary
1	MC0510105-215			Aileron Yoke LH
1	MC0510105-214			Aileron Yoke RH
1	MC0510105-216			Aileron Yoke Transition
1	MC0510105-58			Trim Wheel to Turnbuckle
1	MC0510105-57			Trim Wheel to Disconnect
1	MC0510105-44			Trim Actuator to Turnbuckle
1	MC0510105-45			Trim Actuator to Disconnect
2	MC0510105-217			Aileron Direct
1	MC0510105-13			Aileron Carry Thru
2	MC0510105-59			Flap Direct Upper
2	MC0510105-60			Flap Return Upper
1	MC0510105-63			Flap Return LH Lower
1	MC0510105-64			Flap Return RH Lower
1	MC0510105-61			Flap Direct LH Lower
1	MC0510105-62			Flap Direct RH Lower
1	MC0510105-21			Flap Return Forward
1	MC0510105-22			Flap Direct Forward
1	MC0510105-70			Parking Brake
1	MC0713070-28 2			Cable Assembly Park Brake
1	MCS2295-25-71			Chain Trim Wheel
1	MCS2295-25-67			Chain Trim Actuator
4	MCS2294-25			Chain Connecting Link
4	MC0422280			Aileron Bellcrank Bushing

**172F, G, H, I, K, L 1, F172F, G, H, K, L 1**  
**FR172E, F, G, H 1 1965-1972 1**  
S/N 17251823 thru 17259834 Note 1,  
F172-0086 thru F17200820 Note 2,  
FR1720001 thru FR17200288 Note 3  
Complete Cable Kit P/N CCTK172175-07G (Galvanized)  
Complete Cable Kit P/N CCTK172175-07S (Stainless)  
Complete Pulley Kit P/N PULL-KT-20\* or PULL-KT-21\*

Qty	P/N	Galv	SS	Location
1	MC0510105-205			Rudder Forward LH
1	MC0510105-206			Rudder Forward RH
2	MC0510105-207			Rudder Aft
2	MC0510105-208			Elevator Forward
1	MC0510105-290			Elevator Aft Lower
1	MC0510105-291			Elevator Aft Upper
1	MC0510105-213			Aileron Yoke Primary
1	MC0510105-215			Aileron Yoke LH
1	MC0510105-214			Aileron Yoke RH
1	MC0510105-216			Aileron Yoke Transition
1	MC0510105-220			Trim Wheel to Turnbuckle

Kit continues in next column

**Continued from previous column**

Qty	P/N	Galv	SS	Location
1	MC0510105-221			Trim Wheel to Disconnect
1	MC0510105-44			Trim Actuator to Turnbuckle
1	MC0510105-45			Trim Actuator to Disconnect
2	MC0510105-224			Aileron Direct
1	MC0510105-13			Aileron Carry Thru
2	MC0510105-93			Flap Direct & Retract
2	MC0510105-94			Flap Direct & Retract
1	MC0510105-70			Parking Brake Cable
1	MC0713070-28 2			Cable Assembly Park Brake
1	MCS2295P25-55			Chain Trim Wheel
1	MCS2295-25-67			Chain Trim Actuator
4	MCS2294-25			Chain Connecting Link
4	MC0422280			Aileron Bellcrank Bushing

Note 1: S/N 17251823 thru 17259223 USE PULL-KT-20  
Note 2: USE PULL-KT-20  
Note 3: USE PULL-KT-21

**172L 1, M 1, F172L 1, FR172H 1 1971 1 - 1975 1**  
S/N 17259835 thru 17264202, Note 1  
F17200821 thru F17201234, Note 2  
FR17200289 thru FR17200559 Note 3  
Complete Cable Kit P/N CCTK172175-08G (Galvanized)  
Complete Cable Kit P/N CCTK172175-08S (Stainless)  
Complete Pulley Kit P/N PULL-KT-20\*, -21\* or -22\*

Qty	P/N	Galv	SS	Location
1	MC0510105-205			Rudder Forward LH
1	MC0510105-206			Rudder Forward RH
2	MC0510105-207			Rudder Aft
2	MC0510105-208			Elevator Forward
1	MC0510105-290			Elevator Aft Lower
1	MC0510105-291			Elevator Aft Upper
1	MC0510105-213			Aileron Yoke Primary
1	MC0510105-215			Aileron Yoke LH
1	MC0510105-214			Aileron Yoke RH
1	MC0510105-216			Aileron Yoke Transition
1	MC0510105-220			Trim Wheel to Turnbuckle
1	MC0510105-221			Trim Wheel to Disconnect
1	MC0510105-44			Trim Actuator to Turnbuckle
1	MC0510105-45			Trim Actuator to Disconnect
2	MC0510105-224			Aileron Direct
1	MC0510105-13			Aileron Carry Thru
2	MC0510105-93			Flap Direct & Retract
2	MC0510105-94			Flap Direct & Retract
1	MC0510105-232 2			Parking Brake Cable
1	MC0713070-28 2			Cable Assembly Park Brake
1	MCS2295P25-55			Chain Trim Wheel
1	MCS2295-25-67			Chain Trim Actuator
4	MCS2294-25			Chain Connecting Link
4	MC0422280			Aileron Bellcrank Bushing

Note 1: S/N 17259904 thru 17263458 USE PULL-KT-20  
S/N 17263459 thru 17264202 USE PULL-KT-22  
Note 2: USE PULL-KT-20  
Note 3: USE PULL-KT-21

**172M 1, F172M 1 1975 1**  
S/N 17264203 thru 17265684,  
F17201235 thru F17201384  
Complete Cable Kit P/N CCTK172175-09G (Galvanized)  
Complete Cable Kit P/N CCTK172175-09S (Stainless)  
Complete Pulley Kit P/N PULL-KT-22\*

Qty	P/N	
-----	-----	--



**172M, N, F172M, J, FR172J, K** 1976-1979  
**R172K** 1977-1978  
 S/N 17265685 thru 17270454, F17201385 thru F17201829, FR17200571 thru FR17200640, Note 1  
 R1722000 thru R1722822, Note 2  
 Complete Cable Kit P/N CCKT172175-10G (Galvanized)  
 Complete Cable Kit P/N CCKT172175-10S (Stainless)  
 Complete Pulley Kit P/N PULL-KT-22\*, -21\*

Qty	P/N	Galv	SS	Location
1	MC0510105-239	or	339	Rudder Assembly LH
1	MC0510105-238	or	338	Rudder Assembly RH
2	MC0510105-208	or	308	Elevator Forward
1	MC0510105-291	or	391	Elevator Aft Upper
1	MC0510105-290	or	390	Elevator Aft Lower
1	MC0510105-241	or	341	Aileron Yoke Primary
1	MC0510105-243	or	343	Aileron Yoke LH
1	MC0510105-242	or	342	Aileron Yoke RH
1	MC0510105-244	or	344	Aileron Yoke Transition
1	MC0510105-220	or	320	Trim Wheel to Turnbuckle
1	MC0510105-221	or	321	Trim Wheel to Disconnect
1	MC0510105-44	or	144	Trim Actuator to Turnbuckle
1	MC0510105-45	or	145	Trim Actuator to Disconnect
2	MC0510105-224	or	324	Aileron Direct
1	MC0510105-13	or	113	Aileron Carry Thru
2	MC0510105-93	or	193	Flap Direct & Retract
2	MC0510105-94	or	194	Flap Direct & Retract
1	MC0510105-232	2		Parking Brake Cable
1	MC0713070-28	2		Cable Assembly Park Brake
1	MCS2295P25-55			Chain Trim Wheel
1	MCS2295-25-67			Chain Trim Actuator
4	MCS2294-25			Chain Connecting Link
4	MC0422280			Aileron Bellcrank Bushing

Note 1: S/N FR17200571 thru FR17200590  
 USE PULL-KT-21, FR17200591 thru FR17200640  
 pulley kit not available.

Note 2: Pulley kit not available

**172N, F172N, P, FR172K, 1978-1982**  
**R172K** 1978-1980  
 S/N 17270455 thru 17273850, F17201830 thru F17202169, FR17200641 thru FR17200675, Note 1  
 R1722823 thru R1723353, Note 1  
 Complete Cable Kit P/N CCKT172175-11G (Galvanized)  
 Complete Cable Kit P/N CCKT172175-11S (Stainless)  
 Complete Pulley Kit P/N PULL-KT-22\*

Qty	P/N	Galv	SS	Location
1	MC0510105-239	or	339	Rudder LH
1	MC0510105-238	or	338	Rudder RH
2	MC0510105-208	or	308	Elevator Forward
1	MC0510105-291	or	391	Elevator Aft Upper
1	MC0510105-290	or	390	Elevator Aft Lower
1	MC0510105-241	or	341	Aileron Yoke Primary
1	MC0510105-243	or	343	Aileron Yoke LH
1	MC0510105-242	or	342	Aileron Yoke RH
1	MC0510105-244	or	344	Aileron Yoke Transition
1	MC0510105-220	or	320	Trim Wheel to Turnbuckle
1	MC0510105-221	or	321	Trim Wheel to Disconnect
1	MC0510105-44	or	144	Trim Actuator to Turnbuckle
1	MC0510105-45	or	145	Trim Actuator to Disconnect
2	MC0510105-260	or	360	Aileron Direct to Top
2	MC0510105-262	or	362	Aileron Direct to Bellcrank
1	MC0510105-264	or	364	Cross to LH Bellcrank
1	MC0510105-265	or	365	Cross to RH Bellcrank
2	MC0510105-93	or	193	Flap Direct & Retract
2	MC0510105-94	or	194	Flap Direct & Retract
1	MC0510105-232	2		Parking Brake Cable
1	MC0713070-28	2		Cable Assembly Park Brake
1	MCS2295P25-55			Chain Trim Wheel
1	MCS2295-25-67			Chain Trim Actuator
4	MCS2294-25			Chain Connecting Link
4	MC0422280			Aileron Bellcrank Bushing

Note 1: Pulley kit not available

**172N, P, 1980, 1982, R172K, 1980-81**  
 S/N 17273851 thru 17275187,  
 S/N R1723354 thru R1723454 Note 1  
 Complete Cable Kit P/N CCKT172175-12G (Galvanized)  
 Complete Cable Kit P/N CCKT172175-12S (Stainless)  
 Complete Pulley Kit P/N PULL-KT-22\*

Qty	P/N	Galv	SS	Location
1	MC0510105-239	or	339	Rudder LH
1	MC0510105-238	or	338	Rudder RH
2	MC0510105-208	or	308	Elevator Forward
1	MC0510105-291	or	391	Elevator Aft Upper
1	MC0510105-290	or	390	Elevator Aft Lower
1	MC0510105-241	or	341	Aileron Yoke Primary
1	MC0510105-243	or	343	Aileron Yoke LH
1	MC0510105-242	or	342	Aileron Yoke RH
1	MC0510105-244	or	344	Aileron Yoke Transition
1	MC0510105-220	or	320	Trim Wheel to Turnbuckle
1	MC0510105-221	or	321	Trim Wheel to Disconnect
1	MC0510105-44	or	144	Trim Actuator to Turnbuckle
2	MC0510105-45	or	145	Trim Actuator to Disconnect
2	MC0510105-260	or	360	Aileron Direct to Top
2	MC0510105-262	or	362	Aileron Direct to Bellcrank
1	MC0510105-264	or	364	Cross to LH Bellcrank
1	MC0510105-265	or	365	Cross to RH Bellcrank

Kit continues in next column

Continued from previous column

Qty	P/N	Galv	SS	Location
2	MC0510105-93	or	193	Flap Direct & Retract
2	MC0510105-94	or	194	Flap Direct & Retract
1	MC0510105-278	2		Parking Brake Cable
1	MC0713070-28	2		Cable Assembly Park Brake
1	MCS2295P25-55			Chain Trim Wheel
1	MCS2295-25-67			Chain Trim Actuator
4	MCS2294-25			Chain Connecting Link
4	MC0422280			Aileron Bellcrank Bushing

Note 1: Pulley kit not available

**172P, Q 1982-1986, 172R, S 1996 and On**  
 S/N 17275188 thru 17276673 Note 1  
 17280001 and On, 172S8001 and On Note 2  
 Complete Cable Kit P/N CCKT172175-13G (Galvanized)  
 Complete Cable Kit P/N CCKT172175-13S (Stainless)  
 Complete Pulley Kit P/N PULL-KT-19\*, -22\*

Qty	P/N	Galv	SS	Location
1	MC0510105-239	or	339	Rudder LH
1	MC0510105-238	or	338	Rudder RH
2	MC0510105-208	or	308	Elevator Forward
1	MC0510105-291	or	391	Elevator Aft Upper
1	MC0510105-290	or	390	Elevator Aft Lower
1	MC0510105-241	or	341	Aileron Yoke Primary
1	MC0510105-243	or	343	Aileron Yoke LH
1	MC0510105-242	or	342	Aileron Yoke RH
1	MC0510105-244	or	344	Aileron Yoke Transition
1	MC0560051-4	or	104	Trim Wheel to Turnbuckle
1	MC0560051-5	or	105	Trim Wheel to Disconnect
1	MC0510105-44	or	144	Trim Actuator to Turnbuckle
1	MC0510105-45	or	145	Trim Actuator to Disconnect
2	MC0510105-260	or	360	Aileron Direct to Top
2	MC0510105-262	or	362	Aileron Direct to Bellcrank
1	MC0510105-264	or	364	Cross to LH Bellcrank
1	MC0510105-265	or	365	Cross to RH Bellcrank
2	MC0510105-93	or	193	Flap Direct & Retract
2	MC0510105-94	or	194	Flap Direct & Retract
1	MC0510105-278	2		Parking Brake Cable
1	MC0713070-28	2		Cable Assembly Park Brake
1	MCS2295P25-55			Chain Trim Actuator
1	MCS2295P25-59			Chain Trim Wheel
4	MCS2294-25			Chain Connecting Link
4	MC0422280			Aileron Bellcrank Bushing

Note 1: S/N 17275188 thru 17276673 USE PULL-KT-22  
 Note 2: S/N 17280001 and On USE PULL-KT-19  
 S/N 172S8001 and On USE PULL-KT-19

**F172E 1964**  
 S/N F1720019 thru F1720085  
 Complete Cable Kit P/N CCKT172175-14G (Galvanized)  
 Complete Cable Kit P/N CCKT172175-14S (Stainless)  
 Complete Pulley Kit P/N PULL-KT-19\*

Qty	P/N	Galv	SS	Location
1	MC0510105-205	or	305	Rudder Forward LH
1	MC0510105-206	or	306	Rudder Forward RH
2	MC0510105-207	or	307	Rudder Aft
2	MC0510105-208	or	308	Elevator Forward
1	MC0510105-291	or	391	Elevator Aft Upper
1	MC0510105-290	or	390	Elevator Aft Lower
1	MC0510105-213	or	313	Aileron Yoke Primary
1	MC0510105-215	or	315	Aileron Yoke LH
1	MC0510105-214	or	314	Aileron Yoke RH
1	MC0510105-216	or	316	Aileron Yoke Transition
1	MC0510105-58	or	158	Trim Wheel to Turnbuckle
1	MC0510105-57	or	157	Trim Wheel to Disconnect
1	MC0510105-44	or	144	Trim Actuator to Turnbuckle
1	MC0510105-45	or	145	Trim Actuator to Disconnect
1	MC0510105-217	or	317	Aileron Direct
1	MC0510105-13	or	113	Aileron Carry Thru
2	MC0510105-59	or	159	Flap Direct Upper
2	MC0510105-60	or	160	Flap Return Upper
1	MC0510105-63	or	163	Flap Return LH Lower
1	MC0510105-64	or	164	Flap Return RH Lower
1	MC0510105-61	or	161	Flap Direct LH Lower
1	MC0510105-62	or	162	Flap Direct RH Lower
1	MC0510105-21	or	121	Flap Return Forward
1	MC0510105-22	or	122	Flap Direct Forward
1	MC0510105-70	or	170	Parking Brake
1	MC0713070-28	2		Cable Assembly Park Brake
1	MCS2295-25-71			Chain Trim Wheel
1	MCS2295-25-67			Chain Trim Actuator
4	MCS2294-25			Chain Connecting Link
4	MC0422280			Aileron Bellcrank Bushing

**F172P 1982-1986**  
 S/N F17202170 thru F17202254  
 Complete Cable Kit P/N CCKT172175-15G (Galvanized)  
 Complete Cable Kit P/N CCKT172175-15S (Stainless)  
 Complete Pulley Kit P/N PULL-KT-22\*

Qty	P/N	Galv	SS	Location
1	MC0510105-239	or	339	Rudder LH
1	MC0510105-238	or	338	Rudder RH
2	MC0510105-208	or	308	Elevator Forward
1	MC0510105-291	or	391	Elevator Aft Upper
1	MC0510105-290	or	390	Elevator Aft Lower
1	MC0510105-241	or	341	Aileron Yoke Primary
1	MC0510105-243	or	343	Aileron Yoke LH

Kit continues in next column

Continued from previous column

Qty	P/N	Galv	SS	Location
1	MC0510105-242	or	342	Aileron Yoke RH
1	MC0510105-244	or	344	Aileron Yoke Transition
1	MC0560051-4	or	104	Trim Wheel to Turnbuckle
1	MC0560051-5	or	105	Trim Wheel to Disconnect
1	MC0510105-44	or	144	Trim Actuator to Turnbuckle
1	MC0510105-45	or	145	Trim Actuator to Disconnect
2	MC0510105-260	or	360	Aileron Direct to Top
2	MC0510105-262	or	362	Aileron Direct to Bellcrank
1	MC0510105-264	or	364	Cross to LH Bellcrank
1	MC0510105-265	or	365	Cross to RH Bellcrank
2	MC0510105-93	or	193	Flap Direct & Retract
2	MC0510105-94	or	194	Flap Direct & Retract
1	MC0510105-278	2		Parking Brake Cable
1	MC0713070-28	2		Cable Assembly Park Brake
1	MCS2295P25-57			Chain Trim Actuator
1	MCS2295P25-59			Chain Trim Wheel
4	MCS2294-25			Chain Connecting Link
4	MC0422280			Aileron Bellcrank Bushing

**FR172J 1975-1-1976**  
 S/N FR17200560 thru FR17200570  
 Complete Cable Kit P/N CCKT172175-16G (Galvanized)  
 Complete Cable Kit P/N CCKT172175-16S (Stainless)  
 Complete Pulley Kit P/N PULL-KT-21\*

Qty	P/N	Galv	SS	Location
1	MC0510105-205	or	305	Rudder LH
1	MC0510105-206	or	306	Rudder RH
2	MC0510105-207	or	307	Rudder Aft
2	MC0510105-208	or	308	Elevator Forward
1	MC0510105-291	or	391	Elevator Aft Upper
1	MC0510105-290	or	390	Elevator Aft Lower
1	MC0510105-241	or	341	Aileron Yoke Primary
1	MC0510105-243	or	343	Aileron Yoke LH
1	MC0510105-242	or	342	Aileron Yoke RH
1	MC0510105-244	or	344	Aileron Yoke Transition
1	MC0510105-220	or	320	Trim Wheel to Turnbuckle
1	MC0510105-221	or	321	Trim Wheel to Disconnect
1	MC0510105-44	or	144	Trim Actuator to Turnbuckle
1	MC0510105-45	or	145	Trim Actuator to Disconnect
2	MC0510105-224	or	324	Aileron Direct
1	MC0510105-13	or	113	Aileron Carry Thru
2	MC0510105-93	or	193	Flap Direct & Retract
2	MC0510105-94	or	194	Flap Direct & Retract
1	MC0510105-232	2		Parking Brake Cable
1	MC0713070-28	2		Cable Assembly Park Brake
1	MCS2295-25-67			Chain Trim Actuator
1	MCS2295P25-55			Chain Trim Wheel
4	MCS2294-25			Chain Connecting Link
4	MC0422280			Aileron Bellcrank Bushing

**172RG 1980**  
 S/N 172RG0001 thru 172RG0076  
 Complete Cable Kit P/N CCKT172RG-01G (Galvanized)  
 Complete Cable Kit P/N CCKT172RG-01S (Stainless)

Qty	P/N	Galv	SS	Location
1	MC0510105-272	or	372	Rudder Forward LH
1	MC0510105-271	or	371	Rudder Forward RH
2	MC0510105-270	or	370	Rudder Aft
1	MCS2295P25-29			Chain, Rudder Trim, Forward
1	MCS2295P25-93			Chain, Rudder Trim, Aft
2	MC0510105-269	or	369	Elevator Forward
1	MC0510105-293	or	393	Elevator Aft Upper
1	MC0510105-292	or	392	Elevator Aft Lower
1	MC0510105-241	or	3	

# Flight Control System

## Flight Control Cables - Cessna

Continued from previous page

Qty	P/N	Galv	SS	Location
1	MCS2295P25-29			Chain, Rudder Trim, Forward
1	MCS2295P25-93			Chain, Rudder Trim, Aft
2	MC0510105-269 or 369			Elevator Forward
1	MC0510105-293 or 393			Elevator Aft Upper
1	MC0510105-292 or 392			Elevator Aft Lower
1	MC0510105-241 or 341			Aileron Yoke Primary
1	MC0510105-243 or 343			Aileron Yoke LH
1	MC0510105-242 or 342			Aileron Yoke RH
1	MC0510105-244 or 344			Aileron Yoke Transition
1	MC0560051-6 or 106			Trim Wheel to Turnbuckle
1	MC0510105-44 or 144			Trim Wheel to Disconnect
1	MC0510105-45 or 145			Trim Actuator to Turnbuckle
1	MCS2295P25-59			Chain Trim Wheel
1	MCS2295P25-67			Chain Trim Actuator
2	MC0510105-277 or 377			Aileron Direct to Yoke
2	MC0510105-262 or 362			Aileron Direct to Bellcrank
2	MC0510105-265 or 365			Aileron Carry Thru RH
2	MC0510105-264 or 364			Aileron Carry Thru LH
2	MC0510105-93 or 193			Flap Direct and Retract
2	MC0510105-94 or 194			Flap Direct and Retract
1	MC0510105-278			Parking Brake
4	MCS2294-25			Chain Connecting Link
4	MC0422280			Aileron Bellcrank Bushing

177 1968-1978  
S/N 17700001 thru 17701164

Qty	P/N	SS	Location
1	MC0510105-232		Parking Brake
1	MC0510105-70		Parking Brake

180 1953-1955  
S/N 30000 thru 32150  
Complete Cable Kit P/N CCKT180-01G (Galvanized)  
Complete Cable Kit P/N CCKT180-01S (Stainless Steel)  
Complete Pulley Kit P/N PULL-KT-24\*

Qty	P/N	Galv	SS	Location
2	MC0510105-26 or 126			Rudder Control
2	MC0510105-123			Tailwheel Steering
2	MC0510105-16 or 116			Aileron Direct
1	MC0510105-13 or 113			Aileron Carry Thru
1	MC0510105-24 or 124			Elevator Upper
1	MC0510105-25 or 125			Elevator Lower
2	MC0510105-28 or 128			Stabilator Trim Forward
2	MC0510105-29 or 129			Stabilator Trim Aft
2	MC0510105-59 or 159			Flap Direct Outboard
2	MC0510105-60 or 160			Flap Return Outboard
1	MC0510105-63 or 163			Flap Return Inboard LH
1	MC0510105-64 or 164			Flap Return Inboard RH
1	MC0510105-61 or 161			Flap Direct Inboard LH
1	MC0510105-62 or 162			Flap Direct Inboard RH
1	MC0510105-21 or 121			Flap Return Forward
1	MC0510105-22 or 122			Flap Direct Forward
1	MC0510105-70 or 170			Parking Brake
1	MC0432138-2			Chain Trim Forward
1	MCS2295-25-185			Chain Stab Trim Aft
4	MCS2294-25			Chain Connecting Link
4	MC0422280			Aileron Bellcrank Bushing

180 A 1956-1958  
S/N 32151 thru 50355  
Complete Cable Kit P/N CCKT180-02G (Galvanized)  
Complete Cable Kit P/N CCKT180-02S (Stainless Steel)  
Complete Pulley Kit P/N PULL-KT-24\*

Qty	P/N	Galv	SS	Location
1	MC0510105-51 or 151			Rudder Forward LH
1	MC0510105-71 or 171			Rudder Forward RH
2	MC0510105-52 or 152			Rudder Aft
2	MC0510105-153			Tailwheel Steering
2	MC0510105-16 or 116			Aileron Direct
1	MC0510105-13 or 113			Aileron Carry Thru
1	MC0510105-24 or 124			Elevator Upper
1	MC0510105-25 or 125			Elevator Lower
2	MC0510105-28 or 128			Stabilator Trim Forward
2	MC0510105-29 or 129			Stabilator Trim Aft
2	MC0510105-59 or 159			Flap Direct Outboard
2	MC0510105-60 or 160			Flap Return Outboard
1	MC0510105-63 or 163			Flap Return Inboard LH
1	MC0510105-64 or 164			Flap Return Inboard RH
1	MC0510105-61 or 161			Flap Direct Inboard LH
1	MC0510105-62 or 162			Flap Direct Inboard RH
1	MC0510105-21 or 121			Flap Return Forward
1	MC0510105-22 or 122			Flap Direct Forward
1	MC0510105-70 or 170			Parking Brake
1	MC0432138-2			Chain Trim Forward
1	MCS2295-25-185			Chain Stab Trim Aft
4	MCS2294-25			Chain Connecting Link
4	MC0422280			Aileron Bellcrank Bushing

Available separately for aircraft with camera option

1	MC0510105-128			Stabilizer Trim with Camera
1	MC0510105-167			Rudder LH with Camera
1	MC0510105-168			Rudder RH with Camera
1	MC0510105-131			Elevator Up with Camera
1	MC0510105-132			Elevator Down with Camera

180B 1959  
S/N 50356 thru 50661  
Complete Cable Kit P/N CCKT180-13G (Galvanized)  
Complete Cable Kit P/N CCKT180-13S (Stainless Steel)  
Complete Pulley Kit P/N PULL-KT-24\*

Qty	P/N	Galv	SS	Location
1	MC0510105-51 or 151			Rudder Forward LH
1	MC0510105-71 or 171			Rudder Forward RH
2	MC0510105-52 or 152			Rudder Aft
2	MC0510105-153			Tailwheel Steering
2	MC0510105-16 or 116			Aileron Direct
1	MC0510105-13 or 113			Aileron Carry Thru
1	MC0510105-24 or 124			Elevator Upper
1	MC0510105-25 or 125			Elevator Lower
2	MC0510105-28 or 128			Stabilator Trim Forward
2	MC0510105-29 or 129			Stabilator Trim Aft
2	MC0510105-59 or 159			Flap Direct Outboard
2	MC0510105-60 or 160			Flap Return Outboard
1	MC0510105-63 or 163			Flap Return Inboard LH
1	MC0510105-64 or 164			Flap Return Inboard RH
1	MC0510105-61 or 161			Flap Direct Inboard LH
1	MC0510105-62 or 162			Flap Direct Inboard RH
1	MC0510105-21 or 121			Flap Return Forward
1	MC0510105-22 or 122			Flap Direct Forward
1	MC0510105-70 or 170			Parking Brake
1	MC0713070-28			Cable Assembly Park Brake
1	MC0432138-2			Chain Trim Forward
1	MCS2295-25-185			Chain Stab Trim Aft
4	MCS2294-25			Chain Connecting Link
4	MC0422280			Aileron Bellcrank Bushing

Available separately for aircraft with camera option

1	MC0510105-128			Stabilizer Trim with Camera
1	MC0510105-167			Rudder LH with Camera
1	MC0510105-168			Rudder RH with Camera
1	MC0510105-131			Elevator Up with Camera
1	MC0510105-132			Elevator Down with Camera

180C 1960  
S/N 50662 thru 50744, 50746 thru 50747  
Complete Cable Kit P/N CCKT180-03G (Galvanized)  
Complete Cable Kit P/N CCKT180-03S (Stainless Steel)  
Complete Pulley Kit P/N PULL-KT-25\*

Qty	P/N	Galv	SS	Location
1	MC0510105-51 or 151			Rudder Forward LH
1	MC0510105-71 or 171			Rudder Forward RH
2	MC0510105-52 or 152			Rudder Aft
2	MC0510105-153			Tailwheel Steering
2	MC0510105-16 or 116			Aileron Direct
1	MC0510105-13 or 113			Aileron Carry Thru
1	MC0510105-24 or 124			Elevator Upper
1	MC0510105-25 or 125			Elevator Lower
1	MC0510105-79 or 179			Elevator Trim
2	MC0510105-28 or 128			Stabilator Trim Forward
2	MC0510105-29 or 129			Stabilator Trim Aft
2	MC0510105-59 or 159			Flap Direct Outboard
2	MC0510105-60 or 160			Flap Return Outboard
1	MC0510105-63 or 163			Flap Return Inboard LH
1	MC0510105-64 or 164			Flap Return Inboard RH
1	MC0510105-61 or 161			Flap Direct Inboard LH
1	MC0510105-62 or 162			Flap Direct Inboard RH
1	MC0510105-21 or 121			Flap Return Forward
1	MC0510105-22 or 122			Flap Direct Forward
1	MC0510105-70 or 170			Parking Brake
1	MC0713070-28			Cable Assembly Park Brake
1	MC0432138-2			Chain Trim Forward
1	MCS2295-25-185			Chain Stab Trim Aft
4	MCS2294-25			Chain Connecting Link
4	MC0422280			Aileron Bellcrank Bushing

Available separately for aircraft with camera option

1	MC0510105-128			Stabilizer Trim with Camera
1	MC0510105-167			Rudder LH with Camera
1	MC0510105-168			Rudder RH with Camera
1	MC0510105-131			Elevator Up with Camera
1	MC0510105-132			Elevator Down with Camera

180C D,E,F,G 1960 1964  
S/N 50745, 50748 thru 18051410  
Complete Cable Kit P/N CCKT180-04G (Galvanized)  
Complete Cable Kit P/N CCKT180-04S (Stainless Steel)  
Complete Pulley Kit P/N PULL-KT-25\* or -26\* Note 1

Qty	P/N	Galv	SS	Location
1	MC0510105-51 or 151			Rudder Forward LH
1	MC0510105-71 or 171			Rudder Forward RH
2	MC0510105-52 or 152			Rudder Aft
2	MC0510105-153			Tailwheel Steering
2	MC0510105-16 or 116			Aileron Direct
1	MC0510105-13 or 113			Aileron Carry Thru
1	MC0510105-24 or 124			Elevator Upper
1	MC0510105-25 or 125			Elevator Lower
1	MC0510105-82 or 182			Elevator Trim
2	MC0510105-28 or 128			Stabilator Trim Forward
2	MC0510105-29 or 129			Stabilator Trim Aft
2	MC0510105-59 or 159			Flap Direct Outboard
2	MC0510105-60 or 160			Flap Return Outboard
1	MC0510105-63 or 163			Flap Return Inboard LH
1	MC0510105-64 or 164			Flap Return Inboard RH

Kit continues in next column

Continued from previous column

Qty	P/N	Galv	SS	Location
1	MC0510105-61 or 161			Flap Direct Inboard LH
1	MC0510105-62 or 162			Flap Direct Inboard RH
1	MC0510105-21 or 121			Flap Return Forward
1	MC0510105-22 or 122			Flap Direct Forward
1	MC0510105-70 or 170			Parking Brake
1	MC0713070-28			Cable Assembly Park Brake
1	MC0432138-2			Chain Trim Forward
1	MCS2295-25-185			Chain Stab Trim Aft
4	MCS2294-25			Chain Connecting Link
4	MC0422280			Aileron Bellcrank Bushing

Available separately for aircraft with camera option

1	MC0510105-128			Stabilizer Trim with Camera
1	MC0510105-167			Rudder LH with Camera
1	MC0510105-168			Rudder RH with Camera
1	MC0510105-131			Elevator Up with Camera
1	MC0510105-132			Elevator Down with Camera

Note 1: S/N 50745, 50748 thru 18051183 USE PULL-KT-25  
S/N 18051184 thru 18051410 USE PULL-KT-26

180G 1964  
S/N 18051411 thru 18051445  
Complete Cable Kit P/N CCKT180-05G (Galvanized)  
Complete Cable Kit P/N CCKT180-05S (Stainless Steel)  
Complete Pulley Kit P/N PULL-KT-26\*

Qty	P/N	Galv	SS	Location
1	MC0510105-51 or 151			Rudder Forward LH
1	MC0510105-71 or 171			Rudder Forward RH
2	MC0510105-52 or 152			Rudder Aft
1	MC0510105-73 or 173			Rudder Bar Tie
2	MC0510105-323			Tailwheel Steering
2	MC0510105-16 or 116			Aileron Direct
1	MC0510105-13 or 113			Aileron Carry Thru
1	MC0510105-24 or 124			Elevator Upper
1	MC0510105-25 or 125			Elevator Lower
1	MC0510105-82 or 182			Elevator Trim
2	MC0510105-28 or 128			Stabilator Trim Forward
2	MC0510105-29 or 129			Stabilator Trim Aft
2	MC0510105-59 or 159			Flap Direct Outboard
2	MC0510105-60 or 160			Flap Return Outboard
1	MC0510105-63 or 163			Flap Return Inboard LH
1	MC0510105-64 or 164			Flap Return Inboard RH
1	MC0510105-61 or 161			Flap Direct Inboard LH
1	MC0510105-62 or 162			Flap Direct Inboard RH
1	MC0510105-21 or 121			Flap Return Forward
1	MC0510105-22 or 122			Flap Direct Forward
1	MC0510105-70 or 170			Parking Brake
1	MC0713070-28			Cable Assembly Park Brake
1	MC0432138-2			Chain Trim Forward
1	MCS2295-25-185			Chain Stab Trim Aft
4	MCS2294-25			Chain Connecting Link
4	MC0422280			Aileron Bellcrank Bushing

Available separately for aircraft with camera option

1	MC0510105-128			Stabilizer Trim with Camera
1	MC0510105-167			Rudder LH with Camera
1	MC0510105-168			Rudder RH with Camera
1	MC0510105-131			Elevator Up with Camera
1	MC0510105-132			Elevator Down with Camera

180H 1965  
S/N 18051446 thru 18051607  
Complete Cable Kit P/N CCKT180-06G (Galvanized)  
Complete Cable Kit P/N CCKT180-06S (Stainless Steel)  
Complete Pulley Kit P/N PULL-KT-27\*

Qty	P/N	Galv	SS	Location
1	MC0510105-51 or 151			Rudder Forward LH
1	MC0510105-71 or 171			Rudder Forward RH
2	MC0510105-52 or 152			Rudder Aft
1	MC0510105-73 or 173			Rudder Bar Tie
2	MC0510105-323			Tailwheel Steering
2	MC0510105-222 or 322			Aileron Direct
1	MC0510105-13 or 113			Aileron Carry Thru
1	MC0510105-215 or 315			Aileron Yoke LH
1	MC0510105-214 or 314			Aileron Yoke RH
1	MC0510105-213 or 313			Aileron Yoke Primary
1	MC0510105-216 or 316			Aileron Yoke Transition
1	MC0510105-24 or 124			Elevator Upper
1	MC0510105-25 or 125			Elevator



Continued from previous page

Qty	P/N	Galv	SS	Location
<i>Available separately for aircraft with camera option</i>				
1	MC0510105-128			Stabilizer Trim with Camera
1	MC0510105-167			Rudder LH with Camera
1	MC0510105-168			Rudder RH with Camera
1	MC0510105-131			Elevator Up with Camera
1	MC0510105-132			Elevator Down with Camera
1	MC0432138-2			Chain Trim Forward
1	MCS2295-25-185			Chain Stab Trim Aft
4	MCS2294-25			Chain Connecting Link
4	MC0422280			Aileron Bellcrank Bushing

**180H 1966-1971**  
S/N 18051608 thru 18052206  
Complete Cable Kit P/N CCTK180-07G (Galvanized)  
Complete Cable Kit P/N CCTK180-07S (Stainless Steel)  
Complete Pulley Kit P/N PULL-KT-28\*

Qty	P/N	Galv	SS	Location
1	MC0510105-51 or 151			Rudder Forward LH
1	MC0510105-71 or 171			Rudder Forward RH
2	MC0510105-52 or 152			Rudder Aft
1	MC0510105-73 or 173			Rudder Bar Tie
2	MC0510105-323			Tailwheel Steering
2	MC0510105-222 or 322			Aileron Direct
1	MC0510105-13 or 113			Aileron Carry Thru
1	MC0510105-215 or 315			Aileron Yoke LH
1	MC0510105-214 or 314			Aileron Yoke RH
1	MC0510105-213 or 313			Aileron Yoke Primary
1	MC0510105-216 or 316			Aileron Yoke Transition
1	MC0510105-24 or 124			Elevator Upper
1	MC0510105-25 or 125			Elevator Lower
1	MC0510105-82 or 182			Elevator Trim
2	MC0510105-28 or 128			Stabilator Trim Forward
2	MC0510105-29 or 129			Stabilator Trim Aft
2	MC0510105-225 or 325			Flap Direct Outboard
2	MC0510105-60 or 160			Flap Return Outboard
1	MC0510105-63 or 163			Flap Return Inboard LH
1	MC0510105-64 or 164			Flap Return Inboard RH
1	MC0510105-227 or 327			Flap Direct Inboard LH
1	MC0510105-226 or 326			Flap Direct Inboard RH
1	MC0510105-21 or 121			Flap Return Forward
1	MC0510105-22 or 122			Flap Direct Forward
1	MC0510105-70 or 170			Parking Brake
1	MC0432138-2			Chain Trim Forward
1	MCS2295-25-185			Chain Stab Trim Aft
4	MCS2294-25			Chain Connecting Link
4	MC0422280			Aileron Bellcrank Bushing

*Available separately for aircraft with camera option*

1	MC0510105-128			Stabilizer Trim with Camera
1	MC0510105-167			Rudder LH with Camera
1	MC0510105-168			Rudder RH with Camera
1	MC0510105-131			Elevator Up with Camera
1	MC0510105-132			Elevator Down with Camera

**180H, J 1971-1973**  
S/N 18052207 thru 18052331  
Complete Cable Kit P/N CCTK180-08G (Galvanized)  
Complete Cable Kit P/N CCTK180-08S (Stainless Steel)  
Complete Pulley Kit P/N PULL-KT-83\*

Qty	P/N	Galv	SS	Location
1	MC0510105-51 or 151			Rudder Forward LH
1	MC0510105-71 or 171			Rudder Forward RH
2	MC0510105-52 or 152			Rudder Aft
1	MC0510105-73 or 173			Rudder Bar Tie
2	MC0510105-323			Tailwheel Steering
2	MC0510105-222 or 322			Aileron Direct
1	MC0510105-13 or 113			Aileron Carry Thru
1	MC0510105-215 or 315			Aileron Yoke LH
1	MC0510105-214 or 314			Aileron Yoke RH
1	MC0510105-213 or 313			Aileron Yoke Primary
1	MC0510105-216 or 316			Aileron Yoke Transition
1	MC0510105-24 or 124			Elevator Upper
1	MC0510105-25 or 125			Elevator Lower
1	MC0510105-82 or 182			Elevator Trim
2	MC0510105-28 or 128			Stabilator Trim Forward
2	MC0510105-29 or 129			Stabilator Trim Aft
2	MC0510105-225 or 325			Flap Direct Outboard
2	MC0510105-60 or 160			Flap Return Outboard
1	MC0510105-63 or 163			Flap Return Inboard LH
1	MC0510105-64 or 164			Flap Return Inboard RH
1	MC0510105-227 or 327			Flap Direct Inboard LH
1	MC0510105-226 or 326			Flap Direct Inboard RH
1	MC0510105-21 or 121			Flap Return Forward
1	MC0510105-22 or 122			Flap Direct Forward
1	MC0510105-232			Parking Brake
1	MC0432138-2			Chain Trim Forward
1	MCS2295-25-185			Chain Stab Trim Aft
4	MCS2294-25			Chain Connecting Link
4	MC0422280			Aileron Bellcrank Bushing

*Available separately for aircraft with camera option*

1	MC0510105-128			Stabilizer Trim with Camera
1	MC0510105-167			Rudder LH with Camera
1	MC0510105-168			Rudder RH with Camera
1	MC0510105-131			Elevator Up with Camera
1	MC0510105-132			Elevator Down with Camera

**180J 1973**  
S/N 18052332 thru 18052384  
Complete Cable Kit P/N CCTK180-09G (Galvanized)  
Complete Cable Kit P/N CCTK180-09S (Stainless Steel)  
Complete Pulley Kit P/N PULL-KT-83\*

Qty	P/N	Galv	SS	Location
1	MC0510105-71 or 171			Rudder Forward LH
1	MC0510105-237 or 337			Rudder Forward RH
2	MC0510105-52 or 152			Rudder Aft
1	MC0510105-73 or 173			Rudder Bar Tie
2	MC0510105-323			Tailwheel Steering
2	MC0510105-222 or 322			Aileron Direct
1	MC0510105-13 or 113			Aileron Carry Thru
1	MC0510105-215 or 315			Aileron Yoke LH
1	MC0510105-214 or 314			Aileron Yoke RH
1	MC0510105-213 or 313			Aileron Yoke Primary
1	MC0510105-216 or 316			Aileron Yoke Transition
1	MC0510105-24 or 124			Elevator Upper
1	MC0510105-25 or 125			Elevator Lower
1	MC0510105-82 or 182			Elevator Trim
2	MC0510105-28 or 128			Stabilator Trim Forward
2	MC0510105-29 or 129			Stabilator Trim Aft
2	MC0510105-225 or 325			Flap Direct Outboard
2	MC0510105-60 or 160			Flap Return Outboard
1	MC0510105-63 or 163			Flap Return Inboard LH
1	MC0510105-64 or 164			Flap Return Inboard RH
1	MC0510105-227 or 327			Flap Direct Inboard LH
1	MC0510105-226 or 326			Flap Direct Inboard RH
1	MC0510105-21 or 121			Flap Return Forward
1	MC0510105-22 or 122			Flap Direct Forward
1	MC0432138-2			Chain Stab Trim Forward
1	MCS2295-25-185			Chain Stab Trim Aft
4	MCS2294-25			Chain Connecting Link
4	MC0422280			Bellcrank Aileron Bushing

*Available separately for aircraft with camera option*

1	MC0510105-128			Stabilizer Trim with Camera
1	MC0510105-167			Rudder LH with Camera
1	MC0510105-168			Rudder RH with Camera
1	MC0510105-131			Elevator Up with Camera
1	MC0510105-132			Elevator Down with Camera

**180J 1974-1976**  
S/N 18052385 thru 18052770  
Complete Cable Kit P/N CCTK180-12G (Galvanized)  
Complete Cable Kit P/N CCTK180-12S (Stainless Steel)  
Complete Pulley Kit P/N PULL-KT-29\*

Qty	P/N	Galv	SS	Location
1	MC0510105-71 or 171			Rudder Forward LH
1	MC0510105-237 or 337			Rudder Forward RH
2	MC0510105-52 or 152			Rudder Aft
1	MC0510105-73 or 173			Rudder Bar Tie
2	MC0510105-323			Tailwheel Steering
2	MC0510105-222 or 322			Aileron Direct
1	MC0510105-13 or 113			Aileron Carry Thru
1	MC0510105-215 or 315			Aileron Yoke LH
1	MC0510105-214 or 314			Aileron Yoke RH
1	MC0510105-213 or 313			Aileron Yoke Primary
1	MC0510105-216 or 316			Aileron Yoke Transition
1	MC0510105-24 or 124			Elevator Upper
1	MC0510105-25 or 125			Elevator Lower
1	MC0510105-82 or 182			Elevator Trim
2	MC0510105-28 or 128			Stabilator Trim Forward
2	MC0510105-29 or 129			Stabilator Trim Aft
2	MC0510105-225 or 325			Flap Direct Outboard
2	MC0510105-60 or 160			Flap Return Outboard
1	MC0510105-63 or 163			Flap Return Inboard LH
1	MC0510105-64 or 164			Flap Return Inboard RH
1	MC0510105-227 or 327			Flap Direct Inboard LH
1	MC0510105-226 or 326			Flap Direct Inboard RH
1	MC0510105-21 or 121			Flap Return Forward
1	MC0510105-22 or 122			Flap Direct Forward
1	MC0510105-232			Parking Brake
1	MC0432138-2			Chain Stab Trim Forward
1	MCS2295P25-185			Chain Stab Trim Aft
4	MCS2294-25			Chain Connecting Link
4	MC0422280			Bellcrank Aileron Bushing

*Available separately for aircraft equipped with floats*

1	MC0742022-1			Rudder Return
1	MC0742022-2			Rudder Return

**180K 1977-1980**  
S/N 18052771 thru 18053167  
Complete Cable Kit P/N CCTK180-10G (Galvanized)  
Complete Cable Kit P/N CCTK180-10S (Stainless Steel)  
Complete Pulley Kit P/N PULL-KT-29\*

Qty	P/N	Galv	SS	Location
1	MC0510105-71 or 171			Rudder Forward LH
1	MC0510105-237 or 337			Rudder Forward RH
2	MC0510105-52 or 152			Rudder Aft
1	MC0510105-73 or 173			Rudder Bar Tie
2	MC0760135-106			Tailwheel Steering
1	MC0510105-394			Tailwheel Lock
2	MC0510105-222 or 322			Aileron Direct
1	MC0510105-13 or 113			Aileron Carry Thru

Kit continues in next column

Continued from previous column

Qty	P/N	Galv	SS	Location
1	MC0760135-8 or 108			Aileron Yoke Primary
1	MC0510105-215 or 315			Aileron Yoke LH
1	MC0510105-214 or 314			Aileron Yoke RH
1	MC0510105-216 or 316			Aileron Yoke Transition
1	MC0510105-24 or 124			Elevator Upper
1	MC0510105-25 or 125			Elevator Lower
1	MC0510105-82 or 182			Elevator Trim
2	MC0510105-28 or 128			Stabilator Trim Forward
2	MC0510105-29 or 129			Stabilator Trim Aft
2	MC0510105-225 or 325			Flap Direct Outboard
2	MC0510105-60 or 160			Flap Return Outboard
1	MC0510105-63 or 163			Flap Return Inboard LH
1	MC0510105-64 or 164			Flap Return Inboard RH
1	MC0510105-227 or 327			Flap Direct Inboard LH
1	MC0510105-226 or 326			Flap Direct Inboard RH
1	MC0510105-21 or 121			Flap Return Forward
1	MC0510105-22 or 122			Flap Direct Forward
1	MC0510105-232			Parking Brake
1	MCS2295P25-185			Chain Stab Trim Forward
4	MCS2294-25			Chain Stab Trim Aft
4	MC0422280			Bellcrank Aileron Bushing

*Available separately for aircraft equipped with floats*

1	MC0742022-1			Rudder Return
1	MC0742022-2			Rudder Return

**180K 1981**  
S/N 18053168 thru 18053203  
Complete Cable Kit P/N CCTK180-11G (Galvanized)  
Complete Cable Kit P/N CCTK180-11S (Stainless Steel)  
Complete Pulley Kit P/N PULL-KT-29\*

Qty	P/N	Galv	SS	Location
1	MC0510105-71 or 171			Rudder Forward LH
1	MC0510105-237 or 337			Rudder Forward RH
2	MC0510105-52 or 152			Rudder Aft
1	MC0510105-73 or 173			Rudder Bar Tie
2	MC0760135-106			Tailwheel Steering
1	MC0510105-394			Tailwheel Lock
2	MC0510105-222 or 322			Aileron Direct
1	MC0510105-13 or 113			Aileron Carry Thru
1	MC0760135-8 or 108			Aileron Yoke Primary
1	MC0510105-215 or 315			Aileron Yoke LH
1	MC0510105-214 or 314			Aileron Yoke RH
1	MC0510105-216 or 316			Aileron Yoke Transition
1	MC0510105-24 or 124			Elevator Upper
1	MC0510105-25 or 125			Elevator Lower
1	MC0510105-82 or 182		</	

# Flight Control System

## Flight Control Cables - Cessna

**Continued from previous page**

Qty	P/N	Galv	SS	Location
1	MC0510105-22 or 122			Flap Direct Forward
1	MC0510105-70 or 170			Parking Brake
1	MC0432138-2			Chain Stab Trim Forward
1	MCS2295-25-185			Chain Stab Trim Aft
4	MCS2294-25			Chain Connecting Link
4	MC0422280			Bellcrank Aileron Bushing

**182B 1959**  
S/N 51557 thru 52358  
Complete Cable Kit P/N CCKT182-14G (Galvanized)  
Complete Cable Kit P/N CCKT182-14S (Stainless Steel)  
Complete Pulley Kit P/N PULL-KT-34\*

Qty	P/N	Galv	SS	Location
1	MC0510105-26 or 126			Rudder Control LH
1	MC0510105-66 or 166			Rudder Control RH
1	MC0510105-73 or 173			Rudder Bar Tie
2	MC0510105-16 or 116			Aileron Direct
1	MC0510105-13 or 113			Aileron Carry Thru
2	MC0510105-28 or 128			Stabilator Trim Forward
2	MC0510105-29 or 129			Stabilator Trim Aft
1	MC0510105-24 or 124			Elevator Upper
1	MC0510105-25 or 125			Elevator Lower
1	MC0510105-79 or 179			Elevator Trim
2	MC0510105-59 or 159			Flap Direct Outboard
2	MC0510105-60 or 160			Flap Return Outboard
1	MC0510105-63 or 163			Flap Return Inboard LH
1	MC0510105-64 or 164			Flap Return Inboard RH
1	MC0510105-61 or 161			Flap Direct Inboard LH
1	MC0510105-62 or 162			Flap Direct Inboard RH
1	MC0510105-21 or 121			Flap Return Forward
1	MC0510105-22 or 122			Flap Direct Forward
1	MC0510105-70 or 170			Parking Brake
1	MC0432138-2			Chain Stab Trim Forward
1	MCS2295-25-185			Chain Stab Trim Aft
4	MCS2294-25			Chain Connecting Link
4	MC0422280			Bellcrank Aileron Bushing

**182C 1960 1**  
S/N 52359 thru 52611 & 52613  
Complete Cable Kit P/N CCKT182-02G (Galvanized)  
Complete Cable Kit P/N CCKT182-02S (Stainless Steel)  
Complete Pulley Kit P/N PULL-KT-35\*

Qty	P/N	Galv	SS	Location
1	MC0510105-77 or 177			Rudder Control LH
1	MC0510105-78 or 178			Rudder Control RH
2	MC1260105-9 or 109			Rudder Aft
1	MC0510105-73 or 173			Rudder Bar Tie
2	MC0510105-16 or 116			Aileron Direct
1	MC0510105-13 or 113			Aileron Carry Thru
1	MC0510105-24 or 124			Elevator Upper
1	MC0510105-25 or 125			Elevator Lower
1	MC0510105-79 or 179			Elevator Trim
2	MC0510105-28 or 128			Stabilator Trim Forward
2	MC0510105-29 or 129			Stabilator Trim Aft
2	MC0510105-59 or 159			Flap Direct Outboard
2	MC0510105-60 or 160			Flap Return Outboard
1	MC0510105-63 or 163			Flap Return Inboard LH
1	MC0510105-64 or 164			Flap Return Inboard RH
1	MC0510105-61 or 161			Flap Direct Inboard LH
1	MC0510105-62 or 162			Flap Direct Inboard RH
1	MC0510105-21 or 121			Flap Return Forward
1	MC0510105-22 or 122			Flap Direct Forward
1	MC0510105-70 or 170			Parking Brake
1	MC0713070-28 <sup>2</sup>			Cable Assembly Park Brake
1	MC0432138-2			Chain Stab Trim Forward
1	MCS2295-25-185			Chain Stab Trim Aft
4	MCS2294-25			Chain Connecting Link
4	MC0422280			Bellcrank Aileron Bushing

**182C 1960 1-1961**  
S/N 52612, 52614 thru 53007  
18253008 thru 18253598  
Complete Cable Kit P/N CCKT182-03G (Galvanized)  
Complete Cable Kit P/N CCKT182-03S (Stainless Steel)  
Complete Pulley Kit P/N PULL-KT-35\*

Qty	P/N	Galv	SS	Location
1	MC0510105-77 or 177			Rudder Control LH
1	MC0510105-78 or 178			Rudder Control RH
2	MC1260105-9 or 109			Rudder Aft
1	MC0510105-73 or 173			Rudder Bar Tie
2	MC0510105-16 or 116			Aileron Direct
1	MC0510105-13 or 113			Aileron Carry Thru
1	MC0510105-24 or 124			Elevator Upper
1	MC0510105-25 or 125			Elevator Lower
1	MC0510105-82 or 182			Elevator Trim
2	MC0510105-28 or 128			Stabilator Trim Forward
2	MC0510105-29 or 129			Stabilator Trim Aft
2	MC0510105-59 or 159			Flap Direct Outboard
2	MC0510105-60 or 160			Flap Return Outboard
1	MC0510105-63 or 163			Flap Return Inboard LH
1	MC0510105-64 or 164			Flap Return Inboard RH
1	MC0510105-61 or 161			Flap Direct Inboard LH
1	MC0510105-62 or 162			Flap Direct Inboard RH
1	MC0510105-21 or 121			Flap Return Forward
1	MC0510105-22 or 122			Flap Direct Forward

**Kit continues in the next column**

**Continued from previous column**

Qty	P/N	Galv	SS	Location
1	MC0510105-70 or 170			Parking Brake
1	MC0713070-28 <sup>2</sup>			Cable Assembly Park Brake
1	MC0432138-2			Chain Stab Trim Forward
1	MCS2295-25-185			Chain Stab Trim Aft
4	MCS2294-25			Chain Connecting Link
4	MC0422280			Bellcrank Aileron Bushing

**182E 1962 1**  
S/N 1825399 thru 18253929  
Complete Cable Kit P/N CCKT182-04G (Galvanized)  
Complete Cable Kit P/N CCKT182-04S (Stainless Steel)  
Complete Pulley Kit P/N PULL-KT-36\*

Qty	P/N	Galv	SS	Location
1	MC0510105-77 or 177			Rudder Control LH
1	MC0510105-78 or 178			Rudder Control RH
2	MC1260105-9 or 109			Rudder Aft
2	MC0510105-95 or 195			Aileron Direct
1	MC0510105-13 or 113			Aileron Carry Thru
1	MC0510105-90 or 190			Elevator LH Yoke
1	MC0510105-89 or 189			Elevator RH Yoke
1	MC0510105-88 or 188			Elevator Down Spring
1	MC0510105-86 or 186			Elevator Trim Forward LH
1	MC0510105-97 or 197			Elevator Trim Forward RH
1	MC0510105-87 or 187			Elevator Trim Aft LH
1	MC0510105-98 or 198			Elevator Trim Aft RH
1	MC0510105-93 or 193 <sup>6</sup>			Flap Retract
1	MC0510105-91 or 191			Flap Direct LH
1	MC0510105-94 or 194 <sup>6</sup>			Flap Retract
1	MC0510105-92 or 192			Flap Direct RH
1	MC0510105-85 <sup>2</sup>			Parking Brake
1	MCS2295-25-249			Elevator Trim Chain Forward
1	MCS2295-25-113			Elevator Trim Chain Aft
4	MCS2294-25			Chain Connecting Link
4	MC0422280			Bellcrank Aileron Bushing

**182E 1, F, G 1962 1-1964**  
S/N 18253930 thru 18255844  
Complete Cable Kit P/N CCKT182-05G (Galvanized)  
Complete Cable Kit P/N CCKT182-05S (Stainless Steel)  
Complete Pulley Kit P/N PULL-KT-85\*

Qty	P/N	Galv	SS	Location
1	MC0510105-77 or 177			Rudder Control LH
1	MC0510105-78 or 178			Rudder Control RH
2	MC1260105-9 or 109			Rudder Aft
2	MC0510105-95 or 195			Aileron Direct
1	MC0510105-13 or 113			Aileron Carry Thru
1	MC0510105-90 or 190			Elevator LH Yoke
1	MC0510105-89 or 189			Elevator RH Yoke
1	MC0510105-88 or 188			Elevator Down Spring
1	MC0510105-201 or 301			Elevator Trim Forward LH
1	MC0510105-202 or 302			Elevator Trim Forward RH
1	MC0510105-87 or 187			Elevator Trim Aft LH
1	MC0510105-98 or 198			Elevator Trim Aft RH
1	MC0510105-93 or 193 <sup>6</sup>			Flap Retract
1	MC0510105-91 or 191			Flap Direct LH
1	MC0510105-94 or 194 <sup>6</sup>			Flap Retract
1	MC0510105-92 or 192			Flap Direct RH
1	MC0510105-85 <sup>2</sup>			Parking Brake
1	MCS2295-25-67			Elevator Trim Chain Forward
1	MCS2295-25-71			Elevator Trim Chain Aft
4	MCS2294-25			Chain Connecting Link
4	MC0422280			Aileron Bellcrank Bushing

**182H, J, K 1965-1967**  
S/N 18255845 thru 18258505  
Complete Cable Kit P/N CCKT182-06G (Galvanized)  
Complete Cable Kit P/N CCKT182-06S (Stainless Steel)  
Complete Pulley Kit P/N PULL-KT-85\* or -36\* Note 1

Qty	P/N	Galv	SS	Location
1	MC0510105-77 or 177			Rudder Control LH
1	MC0510105-78 or 178			Rudder Control RH
2	MC1260105-9 or 109			Rudder Aft
2	MC0510105-95 or 195			Aileron Direct
1	MC0510105-13 or 113			Aileron Carry Thru
1	MC0510105-90 or 190			Elevator LH Yoke
1	MC0510105-89 or 189			Elevator RH Yoke
1	MC0510105-201 or 301			Elevator Trim Forward LH
1	MC0510105-202 or 302			Elevator Trim Forward RH
1	MC0510105-87 or 187			Elevator Trim Aft LH
1	MC0510105-98 or 198			Elevator Trim Aft RH
1	MC0510105-93 or 193 <sup>6</sup>			Flap Retract
1	MC0510105-91 or 191			Flap Direct LH
1	MC0510105-94 or 194 <sup>6</sup>			Flap Retract
1	MC0510105-92 or 192			Flap Direct RH
1	MC0510105-85 <sup>2</sup>			Parking Brake
1	MCS2295-25-67			Elevator Trim Chain Forward
1	MCS2295-25-71			Elevator Trim Chain Aft
4	MCS2294-25			Chain Connecting Link
4	MC0422280			Aileron Bellcrank Bushing

Note 1: S/N 18255845 thru 18257625 USE PULL-KT-85  
S/N 18257626 thru 18258399 USE PULL-KT-36  
S/N 18258400 thru 18558505 USE PULL-KT-85

**182L, M, N, P 1968-1973**  
S/N 18258506 thru 18262465  
Complete Cable Kit P/N CCKT182-07G (Galvanized)  
Complete Cable Kit P/N CCKT182-07S (Stainless Steel)  
Complete Pulley Kit P/N PULL-KT-37\*, -38\*, -86\* Note 1

Qty	P/N	Galv	SS	Location
1	MC0510105-77 or 177			Rudder Control LH
1	MC0510105-78 or 178			Rudder Control RH
2	MC1260105-9 or 109			Rudder Aft
2	MC0510105-228 or 328			Aileron Direct
1	MC0510105-13 or 113			Aileron Carry Thru
1	MC1260078-3 or 103			Aileron Yoke RH
1	MC1260078-2 or 102			Aileron Yoke LH
1	MC0510105-90 or 190			Elevator LH Yoke
1	MC0510105-89 or 189			Elevator RH Yoke
1	MC0510105-201 or 301			Elevator Trim Forward LH
1	MC0510105-202 or 302			Elevator Trim Forward RH
1	MC0510105-87 or 187			Elevator Trim Aft LH
1	MC0510105-98 or 198			Elevator Trim Aft RH
1	MC0510105-93 or 193 <sup>6</sup>			Flap Retract
1	MC0510105-91 or 191			Flap Direct LH
1	MC0510105-94 or 194 <sup>6</sup>			Flap Retract
1	MC0510105-92 or 192			Flap Direct RH
1	MC0510105-85 <sup>2</sup>			Parking Brake
1	MC1260078-5 <sup>2</sup>			Aileron Drive Quadrant
1	MCS2295-25-67			Elevator Trim Chain Forward
1	MCS2295-25-71			Elevator Trim Chain Aft
4	MCS2294-25			Chain Connecting Link
4	MC0422280			Aileron Bellcrank Bushing

Note 1: S/N 18258506 thru 18260445 USE PULL-KT-37  
S/N 18260446 thru 18260669 USE PULL-KT-38  
S/N 18260670 thru 18262465 USE PULL-KT-86

**182P 1, Q, R 1, T, F182, F182, O 1974-1981 1**  
S/N 18262466 thru 18267789,  
F1820001 thru F18200169  
Complete Cable Kit P/N CCKT182-08G (Galvanized)  
Complete Cable Kit P/N CCKT182-08S (Stainless Steel)  
Complete Pulley Kit P/N PULL-KT-39\*

Qty	P/N	Galv	SS	Location
1	MC0510105-77 or 177			Rudder Control LH
1	MC0510105-78 or 178			Rudder Control RH
2	MC1260105-9 or 109			Rudder Aft
2	MC0510105-228 or 328			Aileron Direct
1	MC0510105-13 or 113			Aileron Carry Thru
1	MC1260078-3 or 103			Aileron Yoke RH
1	MC1260078-2 or 102			Aileron Yoke LH
1	MC0510105-90 or 190			Elevator LH Yoke
1	MC0510105-89 or 189			Elevator RH Yoke
1	MC0510105-201 or 301			Elevator Trim Forward LH
1	MC0510105-202 or 302			Elevator Trim Forward RH
1	MC0510105-87 or 187			Elevator Trim Aft LH
1	MC0510105-98 or 198			





**182R, T182, 1983-1986**  
S/N 18268294 thru 18268615  
Complete Cable Kit P/N CCTK182-10G (Galvanized)  
Complete Cable Kit P/N CCTK182-10S (Stainless Steel)  
Complete Pulley Kit P/N PULL-KT-39\*

Qty	P/N	Galv	SS	Location
1	MC0510105-77 or 177			Rudder Control LH
1	MC0510105-78 or 178			Rudder Control RH
2	MC1260105-9 or 109			Rudder Aft
2	MC0510105-228 or 328			Aileron Direct
1	MC0510105-13 or 113			Aileron Carry Thru
1	MC1260078-3 or 103			Aileron Yoke RH
1	MC1260078-2 or 102			Aileron Yoke LH
1	MC0510105-90 or 190			Elevator LH Yoke
1	MC0510105-89 or 189			Elevator RH Yoke
1	MC0510105-201 or 301			Elevator Trim Forward LH
1	MC0510105-202 or 302			Elevator Trim Forward RH
1	MC0510105-87 or 187			Elevator Trim Aft LH
1	MC0510105-98 or 198			Elevator Trim Aft RH
1	MC0510105-93 or 193	6		Flap Retract
1	MC0510105-91 or 191			Flap Direct LH
1	MC0510105-94 or 194	6		Flap Retract
1	MC0510105-92 or 192			Flap Direct RH
1	MC0510105-279	2		Parking Brake
1	MC1260078-5	2		Aileron Drive Quadrant
1	MCS2295P25-67			Elevator Trim Chain Forward
1	MCS2295P25-71			Elevator Trim Chain Aft
4	MCS2294-25			Chain Connecting Link
4	MC0422280			Bellcrank Aileron Bushing

**R182, TR182, FR182 1978-1981**  
S/N R1820001 thru R1820169,  
FR1820001 thru FR1820070  
Complete Cable Kit P/N CCTK182-11G (Galvanized)  
Complete Cable Kit P/N CCTK182-11S (Stainless Steel)  
Complete Pulley Kit P/N PULL-KT-40\*

Qty	P/N	Galv	SS	Location
1	MC0510105-77 or 177			Rudder Control LH
1	MC0510105-78 or 178			Rudder Control RH
2	MC1260105-18 or 118			Rudder Aft
2	MC0510105-228 or 328			Aileron Direct
1	MC0510105-13 or 113			Aileron Carry Thru
1	MC0510105-250 or 350			Elevator LH Yoke
1	MC0510105-249 or 349			Elevator RH Yoke
1	MC0510105-245 or 345			Elevator Trim LH Forward
1	MC0510105-246 or 346			Elevator Trim RH Forward
1	MC0510105-247 or 347			Elevator Trim LH Aft
1	MC0510105-248 or 348			Elevator Trim RH Aft
1	MC0510105-93 or 193	6		Flap Retract
1	MC0510105-91 or 191			Flap Direct LH
1	MC0510105-94 or 194	6		Flap Retract
1	MC0510105-92 or 192			Flap Direct RH
1	MC0510105-233 or 333			Parking Brake
1	MCS2295P25-67			Elevator Trim Chain Forward
1	MCS2295P25-71			Elevator Trim Chain Aft
4	MCS2294-25			Chain Connecting Link
4	MC0422280			Bellcrank Aileron Bushing

**R182, TR182, 1981, 1986**  
S/N R18201680 thru R18202041  
Complete Cable Kit P/N CCTK182-12G (Galvanized)  
Complete Cable Kit P/N CCTK182-12S (Stainless Steel)  
Complete Pulley Kit P/N PULL-KT-40\*

Qty	P/N	Galv	SS	Location
1	MC0510105-77 or 177			Rudder Control LH
1	MC0510105-78 or 178			Rudder Control RH
2	MC1260105-18 or 118			Rudder Aft
2	MC0510105-228 or 328			Aileron Direct
1	MC0510105-13 or 113			Aileron Carry Thru
1	MC0510105-250 or 350			Elevator LH Yoke
1	MC0510105-249 or 349			Elevator RH Yoke
1	MC0510105-245 or 345			Elevator Trim LH Forward
1	MC0510105-246 or 346			Elevator Trim RH Forward
1	MC0510105-247 or 347			Elevator Trim LH Aft
1	MC0510105-248 or 348			Elevator Trim RH Aft
1	MC0510105-93 or 193	6		Flap Retract
1	MC0510105-91 or 191			Flap Direct LH
1	MC0510105-94 or 194	6		Flap Retract
1	MC0510105-92 or 192			Flap Direct RH
1	MC0510105-279	2		Parking Brake
1	MCS2295P25-67			Elevator Trim Chain Forward
1	MCS2295P25-71			Elevator Trim Chain Aft
4	MCS2294-25			Chain Connecting Link
4	MC0422280			Bellcrank Aileron Bushing

**182S, 182T, T182T 1997 and On**  
S/N 18280001 and On, T18280001 and On  
Complete Cable Kit P/N CCTK182-13G (Galvanized)  
Complete Cable Kit P/N CCTK182-13S (Stainless Steel)  
Complete Pulley Kit P/N PULL-KT-80\*

Qty	P/N	Galv	SS	Location
1	MC0510105-77 or 177			Rudder Control LH
1	MC0510105-78 or 178			Rudder Control RH
2	MC1260105-9 or 109			Rudder Aft
2	MC0510105-228 or 328			Aileron Direct
1	MC0510105-13 or 113			Aileron Carry Thru
1	MC0510105-90 or 190			Elevator LH Yoke
1	MC0510105-89 or 189			Elevator RH Yoke

Kit continues in next column

Continued from previous column

Qty	P/N	Galv	SS	Location
1	MC0510105-201 or 301			Elevator Trim Forward LH
1	MC0510105-202 or 302			Elevator Trim Forward RH
1	MC0510105-87 or 187			Elevator Trim Aft LH
1	MC0510105-98 or 198			Elevator Trim Aft RH
1	MC0510105-93 or 193	6		Flap Retract
1	MC0510105-91 or 191			Flap Direct LH
1	MC0510105-94 or 194	6		Flap Retract
1	MC0510105-92 or 192			Flap Direct RH
1	MC1260078-5 or 105			Aileron Yoke Primary
1	MC1260078-7 or 107			Aileron Yoke LH
1	MC1260078-8 or 108			Aileron Yoke RH
1	MC0510105-279	2		Parking Brake
1	MCS2295P25-67			Elevator Trim Chain Forward
1	MCS2295P25-71			Elevator Trim Chain Aft
4	MCS2294-25			Chain Connecting Link
4	MC0422280			Bellcrank Aileron Bushing

**185 1961**  
S/N 1850001 thru 1850237  
Complete Cable Kit P/N CCTK185-01G (Galvanized)  
Complete Cable Kit P/N CCTK185-01S (Stainless Steel)  
Complete Pulley Kit P/N PULL-KT-30\*

Qty	P/N	Galv	SS	Location
1	MC0510105-51 or 151			Rudder Forward LH
1	MC0510105-71 or 171			Rudder Forward RH
2	MC0510105-52 or 152			Rudder Aft
2	MC0510105-196	2		Tailwheel Steering
1	MC0510105-73 or 173			Rudder Trim
1	MC0510105-82 or 182			Elevator Trim
1	MC0510105-24 or 124			Elevator Upper
1	MC0510105-25 or 125			Elevator Lower
2	MC0510105-28 or 128			Stabilator Trim Forward
2	MC0510105-29 or 129			Stabilator Trim Aft
2	MC0510105-16 or 116			Aileron Direct
1	MC0510105-13 or 113			Aileron Carry Thru
2	MC0510105-59 or 159			Flap Direct Outboard
2	MC0510105-60 or 160			Flap Return Outboard
1	MC0510105-63 or 163			Flap Return Inboard LH
1	MC0510105-64 or 164			Flap Return Inboard RH
1	MC0510105-61 or 161			Flap Direct Inboard LH
1	MC0510105-62 or 162			Flap Direct Inboard RH
1	MC0510105-21 or 121			Flap Return Forward
1	MC0510105-22 or 122			Flap Direct Forward
1	MC0510105-70 or 170			Parking Brake
1	MC0713070-28	2		Cable Assembly Park Brake
1	MCS2295P25-321			Chain Stabilator Trim Fwd
1	MCS2295-25-185			Chain Stabilator Trim Aft
4	MCS2294-25			Chain Connecting Link
4	MC0422280			Bellcrank Aileron Bushing

**185A,B,C 1962-1964**  
S/N 1850238 thru 1850768  
Complete Cable Kit P/N CCTK185-02G (Galvanized)  
Complete Cable Kit P/N CCTK185-02S (Stainless Steel)  
Complete Pulley Kit P/N PULL-KT-30\*

Qty	P/N	Galv	SS	Location
1	MC0510105-51 or 151			Rudder Forward LH
1	MC0510105-71 or 171			Rudder Forward RH
2	MC0510105-52 or 152			Rudder Aft
2	MC0510105-199	2		Tailwheel Steering
1	MC0510105-73 or 173			Rudder Trim
1	MC0510105-82 or 182			Elevator Trim
1	MC0510105-24 or 124			Elevator Upper
1	MC0510105-25 or 125			Elevator Lower
2	MC0510105-28 or 128			Stabilator Trim Forward
2	MC0510105-29 or 129			Stabilator Trim Aft
2	MC0510105-16 or 116			Aileron Direct
1	MC0510105-13 or 113			Aileron Carry Thru
2	MC0510105-59 or 159			Flap Direct Outboard
2	MC0510105-60 or 160			Flap Return Outboard
1	MC0510105-63 or 163			Flap Return Inboard LH
1	MC0510105-64 or 164			Flap Return Inboard RH
1	MC0510105-61 or 161			Flap Direct Inboard LH
1	MC0510105-62 or 162			Flap Direct Inboard RH
1	MC0510105-21 or 121			Flap Return Forward
1	MC0510105-22 or 122			Flap Direct Forward
1	MC0510105-70 or 170			Parking Brake
1	MC0713070-28	2		Cable Assembly Park Brake
1	MCS2295-25-185			Chain Stabilator Trim Aft
1	MCS2295P25-321			Chain Stabilator Trim Fwd
4	MCS2294-25			Chain Connecting Link
4	MC0422280			Bellcrank Aileron Bushing

**185C 1964**  
S/N 1850769 thru 1850776  
Complete Cable Kit P/N CCTK185-03G (Galvanized)  
Complete Cable Kit P/N CCTK185-03S (Stainless Steel)  
Complete Pulley Kit P/N PULL-KT-30\*

Qty	P/N	Galv	SS	Location
1	MC0510105-51 or 151			Rudder Forward LH
1	MC0510105-71 or 171			Rudder Forward RH
2	MC0510105-52 or 152			Rudder Aft
2	MC0510105-323	2		Tailwheel Steering
1	MC0510105-73 or 173			Rudder Trim
1	MC0510105-82 or 182			Elevator Trim

Kit continues in next column

Continued from previous column

Qty	P/N	Galv	SS	Location
1	MC0510105-24 or 124			Elevator Upper
1	MC0510105-25 or 125			Elevator Lower
2	MC0510105-28 or 128			Stabilator Trim Forward
2	MC0510105-29 or 129			Stabilator Trim Aft
2	MC0510105-16 or 116			Aileron Direct
1	MC0510105-13 or 113			Aileron Carry Thru
2	MC0510105-59 or 159			Flap Direct Outboard
2	MC0510105-60 or 160			Flap Return Outboard
1	MC0510105-63 or 163			Flap Return Inboard LH
1	MC0510105-64 or 164			Flap Return Inboard RH
1	MC0510105-61 or 161			Flap Direct Inboard LH
1	MC0510105-62 or 162			Flap Direct Inboard RH
1	MC0510105-21 or 121			Flap Return Forward
1	MC0510105-22 or 122			Flap Direct Forward
1	MC0510105-70 or 170			Parking Brake
1	MC0713070-28	2		Cable Assembly Park Brake
1	MCS2295P25-321			Chain Stabilator Trim Fwd
1	MCS2295-25-185			Chain Stabilator Trim Aft
4	MCS2294-25			Chain Connecting Link
4	MC0422280			Bellcrank Aileron Bushing

**185D 1965**  
S/N 1850777 thru 1850967  
Complete Cable Kit P/N CCTK185-04G (Galvanized)  
Complete Cable Kit P/N CCTK185-04S (Stainless Steel)  
Complete Pulley Kit P/N PULL-KT-31\*

Qty	P/N	Galv	SS	Location
1	MC0510105-51 or 151			Rudder Forward LH
1	MC0510105-71 or 171			Rudder Forward RH
2	MC0510105-52 or 152			Rudder Aft
2	MC0510105-323	2		Tailwheel Steering
1	MC0510105-73 or 173			Rudder Trim
1	MC0510105-82 or 182			Elevator Trim
1	MC0510105-24 or 124			Elevator Upper
1	MC0510105-25 or 125			Elevator Lower
2	MC0510105-28 or 128			Stabilator Trim Forward
2	MC0510105-29 or 129			Stabilator Trim Aft
1	MC0510105-16 or 116			Aileron Direct
1	MC0510105-13 or 113			Aileron Carry Thru
2	MC0510105-59 or 159			Flap Direct Outboard
2	MC0510105-60 or 160			Flap Return Outboard
1	MC0510105-63 or 163			Flap Return Inboard LH
1	MC0510105-64 or 164			Flap Return Inboard RH
1	MC0510105-213 or 313			Aileron Yoke Primary
1	MC0510105-214 or 314			Aileron Yoke RH
1	MC0510105-212 or 312			Aileron Yoke Transition
2	MC0510105-226 or 322			Aileron Direct
1	MC0510105-13 or 113			Aileron Carry Thru
2	MC0510105-59 or 159			Flap Direct Outboard
2	MC0510105-60 or 160			Flap Return Outboard
1	MC0510105-63 or 163			Flap Return Inboard LH
1	MC0510105-64 or 164			Flap Return Inboard RH
1	MC0510105-61 or 161			Flap Direct Inboard LH
1	MC0510105-62 or 162			Flap Direct Inboard RH
1	MC0510105-21 or 121			Flap Return Forward
1	MC0510105-22 or 122			Flap Direct Forward
1	MC0510105-70 or 170			Parking Brake
1	MCS2295-25-185			Chain Stabilator Trim Fwd
1	MCS2295P25-321			Chain Stabilator Trim Aft
4	MCS2294-25			Chain Connecting Link
4	MC0422280			Bellcrank Aileron Bushing

**185E, A185E 1966-1971**  
S/N 1850968 thru 18501901  
Complete Cable Kit P/N CCTK185-05G (Galvanized)  
Complete Cable Kit P/N CCTK185-05S (Stainless Steel)  
Complete Pulley Kit P/N PULL-KT-32\*

Qty	P/N	Galv	SS	Location
1	MC0510105-51 or 151			Rudder Forward LH
1	MC0510105-71 or 171			Rudder Forward RH
2	MC0510105-52 or 152			Rudder Aft
2	MC0510105-323	2		Tailwheel Steering
1	MC0510105-73 or 17			

# Flight Control System

## Flight Control Cables - Cessna

Continued from previous page  
**Qty P/N Galv SS Location**  
 4 MCS2294-25 Chain Connecting Link  
 4 MC0422280 Bellcrank Aileron Bushing

**A185F1 1971-1973**  
 S/N 18501902 thru 18502206  
 Complete Cable Kit P/N CCTK185-06G (Galvanized)  
 Complete Cable Kit P/N CCTK185-06S (Stainless Steel)  
 Complete Pulley Kit P/N PULL-KT-84\*

Qty	P/N	Galv SS	Location
1	MC0510105-51 or 151		Rudder Forward LH
1	MC0510105-71 or 171		Rudder Forward RH
2	MC0510105-52 or 152		Rudder Aft
2	MC0510105-323		Tailwheel Steering
1	MC0510105-73 or 173		Rudder Trim
1	MC0510105-82 or 182		Elevator Trim
1	MC0510105-24 or 124		Elevator Upper
1	MC0510105-25 or 125		Elevator Lower
2	MC0510105-28 or 128		Stabilator Trim Forward
2	MC0510105-29 or 129		Stabilator Trim Aft
1	MC0510105-215 or 315		Aileron Yoke LH
1	MC0510105-214 or 314		Aileron Yoke RH
1	MC0510105-213 or 313		Aileron Yoke Primary
1	MC0510105-216 or 316		Aileron Yoke Transition
2	MC0510105-222 or 322		Aileron Direct
1	MC0510105-13 or 113		Aileron Carry Thru
2	MC0510105-225 or 325		Flap Direct Outboard
2	MC0510105-60 or 160		Flap Return Outboard
1	MC0510105-63 or 163		Flap Return Inboard LH
1	MC0510105-64 or 164		Flap Return Inboard RH
1	MC0510105-227 or 327		Flap Direct Inboard LH
1	MC0510105-226 or 326		Flap Direct Inboard RH
1	MC0510105-21 or 121		Flap Return Forward
1	MC0510105-22 or 122		Flap Direct Forward
1	MC0510105-232		Parking Brake
1	MCS2295P25-321		Chain Stabilator Trim Fwd
1	MCS2295-25-185		Chain Stabilator Trim Aft
4	MCS2294-25		Chain Connecting Link
4	MC0422280		Bellcrank Aileron Bushing

**A185F1 1973**  
 S/N 18502207 thru 18502310  
 Complete Cable Kit P/N CCTK185-11G (Galvanized)  
 Complete Cable Kit P/N CCTK185-11S (Stainless Steel)  
 Complete Pulley Kit P/N PULL-KT-84\*

Qty	P/N	Galv SS	Location
1	MC0510105-51 or 151		Rudder Forward LH
1	MC0510105-237 or 337		Rudder Forward RH
2	MC0510105-52 or 152		Rudder Aft
2	MC0510105-323		Tailwheel Steering
1	MC0510105-73 or 173		Rudder Trim
1	MC0510105-82 or 182		Elevator Trim
1	MC0510105-24 or 124		Elevator Upper
1	MC0510105-25 or 125		Elevator Lower
2	MC0510105-28 or 128		Stabilator Trim Forward
2	MC0510105-29 or 129		Stabilator Trim Aft
1	MC0510105-215 or 315		Aileron Yoke LH
1	MC0510105-214 or 314		Aileron Yoke RH
1	MC0510105-213 or 313		Aileron Yoke Primary
1	MC0510105-216 or 316		Aileron Yoke Transition
2	MC0510105-222 or 322		Aileron Direct
1	MC0510105-13 or 113		Aileron Carry Thru
2	MC0510105-225 or 325		Flap Direct Outboard
2	MC0510105-60 or 160		Flap Return Outboard
1	MC0510105-63 or 163		Flap Return Inboard LH
1	MC0510105-64 or 164		Flap Return Inboard RH
1	MC0510105-227 or 327		Flap Direct Inboard LH
1	MC0510105-226 or 326		Flap Direct Inboard RH
1	MC0510105-21 or 121		Flap Return Forward
1	MC0510105-22 or 122		Flap Direct Forward
1	MC0510105-232		Parking Brake
1	MCS2295P25-321		Chain Stabilator Trim Fwd
1	MCS2295-25-185		Chain Stabilator Trim Aft
4	MCS2294-25		Chain Connecting Link
4	MC0422280		Bellcrank Aileron Bushing

**A185F1 1974-1976**  
 S/N 18502311 thru 18503153  
 Complete Cable Kit P/N CCTK185-07G (Galvanized)  
 Complete Cable Kit P/N CCTK185-07S (Stainless Steel)  
 Complete Pulley Kit P/N PULL-KT-33\*

Qty	P/N	Galv SS	Location
1	MC0510105-51 or 151		Rudder Forward LH
1	MC0510105-237 or 337		Rudder Forward RH
2	MC0510105-52 or 152		Rudder Control Aft
2	MC0510105-323		Tailwheel Steering
1	MC0510105-73 or 173		Rudder Trim
1	MC0510105-82 or 182		Elevator Trim
1	MC0510105-24 or 124		Elevator Upper
1	MC0510105-25 or 125		Elevator Lower
2	MC0510105-28 or 128		Stabilator Trim Forward
2	MC0510105-29 or 129		Stabilator Trim Aft
1	MC0510105-215 or 315		Aileron Yoke LH
1	MC0510105-214 or 314		Aileron Yoke RH
1	MC0510105-213 or 313		Aileron Yoke Primary
1	MC0510105-216 or 316		Aileron Yoke Transition

Kit continues in next column

Continued from previous column  
**Qty P/N Galv SS Location**  
 2 MC0510105-222 or 322 Aileron Direct  
 1 MC0510105-13 or 113 Aileron Carry Thru  
 2 MC0510105-225 or 325 Flap Direct Outboard  
 2 MC0510105-60 or 160 Flap Return Outboard  
 1 MC0510105-63 or 163 Flap Return Inboard LH  
 1 MC0510105-64 or 164 Flap Return Inboard RH  
 1 MC0510105-227 or 327 Flap Direct Inboard LH  
 1 MC0510105-226 or 326 Flap Direct Inboard RH  
 1 MC0510105-21 or 121 Flap Return Forward  
 1 MC0510105-22 or 122 Flap Direct Forward  
 1 MC0510105-232 Parking Brake  
 1 MCS2295P25-321 Chain Stabilator Trim Fwd  
 1 MCS2295P25-185 Chain Stabilator Trim Aft  
 4 MCS2294-25 Chain Connecting Link  
 4 MC0422280 Bellcrank Aileron Bushing

*Available separately for aircraft equipped with floats*  
 1 MC0742022-1 Rudder Return  
 1 MC0742022-2 Rudder Return

**185F1 1977-1980**  
 S/N 18503154 thru 18504138  
 Complete Cable Kit P/N CCTK185-08G (Galvanized)  
 Complete Cable Kit P/N CCTK185-08S (Stainless Steel)  
 Complete Pulley Kit P/N PULL-KT-33\*

Qty	P/N	Galv SS	Location
1	MC0510105-51 or 151		Rudder Forward LH
1	MC0510105-237 or 337		Rudder Forward RH
2	MC0510105-52 or 152		Rudder Control Aft
2	MC0760135-106		Tailwheel Steering
1	MC0510105-394		Tailwheel Lock
1	MC0510105-73 or 173		Rudder Trim
1	MC0510105-82 or 182		Elevator Trim
1	MC0510105-24 or 124		Elevator Upper
1	MC0510105-25 or 125		Elevator Lower
2	MC0510105-28 or 128		Stabilator Trim Forward
2	MC0510105-29 or 129		Stabilator Trim Aft
1	MC0510105-215 or 315		Aileron Yoke LH
1	MC0510105-214 or 314		Aileron Yoke RH
1	MC0760135-8 or 108		Aileron Yoke Primary
1	MC0510105-216 or 316		Aileron Yoke Transition
2	MC0510105-222 or 322		Aileron Direct
1	MC0510105-13 or 113		Aileron Carry Thru
2	MC0510105-225 or 325		Flap Direct Outboard
2	MC0510105-60 or 160		Flap Return Outboard
1	MC0510105-63 or 163		Flap Return Inboard LH
1	MC0510105-64 or 164		Flap Return Inboard RH
1	MC0510105-227 or 327		Flap Direct Inboard LH
1	MC0510105-226 or 326		Flap Direct Inboard RH
1	MC0510105-21 or 121		Flap Return Forward
1	MC0510105-22 or 122		Flap Direct Forward
1	MC0510105-232		Parking Brake
1	MCS2295P25-321		Chain Stabilator Trim Fwd
1	MCS2295P25-185		Chain Stabilator Trim Aft
4	MCS2294-25		Chain Connecting Link
4	MC0422280		Bellcrank Aileron Bushing

*Available separately for aircraft equipped with floats*  
 1 MC0742022-1 Rudder Return  
 1 MC0742022-2 Rudder Return

**185F1 1981-1982**  
 S/N 18504139 thru 18504379, 18504381 thru 18504391  
 Complete Cable Kit P/N CCTK185-09G (Galvanized)  
 Complete Cable Kit P/N CCTK185-09S (Stainless Steel)  
 Complete Pulley Kit P/N PULL-KT-33\*

Qty	P/N	Galv SS	Location
1	MC0510105-51 or 151		Rudder Forward LH
1	MC0510105-237 or 337		Rudder Forward RH
2	MC0510105-52 or 152		Rudder Control Aft
2	MC0760135-106		Tailwheel Steering
1	MC0510105-394		Tailwheel Lock
1	MC0510105-73 or 173		Rudder Trim
1	MC0510105-82 or 182		Elevator Trim
1	MC0510105-24 or 124		Elevator Upper
1	MC0510105-25 or 125		Elevator Lower
2	MC0510105-28 or 128		Stabilator Trim Forward
2	MC0510105-29 or 129		Stabilator Trim Aft
1	MC0510105-215 or 315		Aileron Yoke LH
1	MC0510105-214 or 314		Aileron Yoke RH
1	MC0760135-8 or 108		Aileron Yoke Primary
1	MC0510105-216 or 316		Aileron Yoke Transition
2	MC0510105-222 or 322		Aileron Direct
1	MC0510105-13 or 113		Aileron Carry Thru
2	MC0510105-225 or 325		Flap Direct Outboard
2	MC0510105-60 or 160		Flap Return Outboard
1	MC0510105-63 or 163		Flap Return Inboard LH
1	MC0510105-64 or 164		Flap Return Inboard RH
1	MC0510105-227 or 327		Flap Direct Inboard LH
1	MC0510105-226 or 326		Flap Direct Inboard RH
1	MC0510105-21 or 121		Flap Return Forward
1	MC0510105-22 or 122		Flap Direct Forward
1	MC0510105-278		Parking Brake
1	MCS2295P25-321		Chain Stabilator Trim Fwd
1	MCS2295P25-185		Chain Stabilator Trim Aft
4	MCS2294-25		Chain Connecting Link

Kit continues in next column

Continued from previous column  
**Qty P/N Galv SS Location**  
 4 MC0422280 Bellcrank Aileron Bushing  
*Available separately for aircraft equipped with floats*  
 1 MC0742022-1 Rudder Return  
 1 MC0742022-2 Rudder Return

**A185F1 1982-1985**  
 S/N 18504380, 18504392 thru 18504448  
 Complete Cable Kit P/N CCTK185-10G (Galvanized)  
 Complete Cable Kit P/N CCTK185-10S (Stainless Steel)  
 Complete Pulley Kit P/N PULL-KT-33\*

Qty	P/N	Galv SS	Location
1	MC0510105-51 or 151		Rudder Forward LH
1	MC0510105-237 or 337		Rudder Forward RH
2	MC0510105-52 or 152		Rudder Aft
2	MC0760135-106		Tailwheel Steering
1	MC0510105-394		Tailwheel Lock
1	MC0510105-73 or 173		Rudder Trim
1	MC0510105-82 or 182		Elevator Trim
1	MC0510105-24 or 124		Elevator Upper
1	MC0510105-25 or 125		Elevator Lower
2	MC0510105-28 or 128		Stabilator Trim Forward
2	MC0510105-29 or 129		Stabilator Trim Aft
1	MC0510105-215 or 315		Aileron Yoke LH
1	MC0510105-214 or 314		Aileron Yoke RH
1	MC0760135-8 or 108		Aileron Yoke Primary
1	MC0510105-216 or 316		Aileron Yoke Transition
2	MC0510105-225 or 325		Flap Direct Outboard
2	MC0510105-226 or 326		Flap Direct Inboard LH
1	MC0510105-264 or 364		Flap Direct Inboard RH
1	MC0510105-265 or 365		Flap Return Forward
2	MC0510105-227 or 327		Flap Direct Inboard LH
1	MC0510105-226 or 326		Flap Direct Inboard RH
1	MC0510105-21 or 121		Flap Return Forward
1	MC0510105-22 or 122		Flap Direct Forward
2	MC0510105-60 or 160		Flap Return Outboard
1	MC0510105-63 or 163		Flap Return Inboard LH
1	MC0510105-64 or 164		Flap Return Inboard RH
1	MC0510105-278		Parking Brake
1	MCS2295P25-321		Stabilator Trim Forward
1	MCS2295P25-185		Stabilator Trim Aft
4	MCS2294-25		Chain Connecting Link
4	MC0422280		Bellcrank Aileron Bushing

*Available separately for aircraft equipped with floats*  
 1 MC0742022-1 Rudder Return  
 1 MC0742022-2 Rudder Return

**188, A188 1966-1967**  
 S/N 1880001 thru 1880293  
 Complete Cable Kit P/N CCTK188-01  
 Complete Pulley Kit P/N PULL-KT-41\*

Qty	P/N	Location
1	MC1660300-13	Flap Direct LH Bellcrank
1	MC1660300-12	Flap Direct RH Bellcrank
1	MC1660300-15	Flap Retract LH Bellcrank
1	MC1660300-14	Flap Retract RH Bellcrank
1	1660300-17	Flap Retract to Lever
1	1660300-16	Flap Direct to Lever
2	MC1660300-8	Aileron Direct to Torque Tube
2	MC1660300-9	Aileron Direct to Bellcrank
1	MC1660300-11	Aileron Carry Thru LH
1	MC1660300-10	Aileron Carry Thru RH
1	MC1660300-3	Elevator Down Forward
1	MC1660300-5	Elevator Up
1	MC1660300-4	Elevator Down Aft
1	MC1660300-6	Elevator Trim Forward Upper
1	MC1660300-7	Elevator Trim Forward Lower
1	MC0510105-187	Elevator Trim Aft Lower
1	MC0510105-198	Elevator Trim Aft Upper
1	MCS2295-25-71	Elevator Trim Chain Forward
4	MCS2294-25	Elevator Trim Chain Aft
2	MC1660300-1	Connecting Link
2	MC1660300-2	Rudder Forward
2	MC0510105-152	Rudder Center
2	MC0510105-323	Rudder Aft
4	MC0422280	Tailwheel Steering
		Bellcrank Aileron Bushing

**188, A188 1966-1967**  
 S/N 1880294 thru 1880317  
 Complete Cable Kit P/N CCTK188-02  
 Complete Pulley Kit P/N PULL-KT-41\*

Qty	P/N	Location
1	MC1660300-13	Flap Direct LH Bellcrank
1	MC1660300-12	Flap Direct RH Bellcrank
1	MC1660300-15	Flap Retract LH Bellcrank
1	MC1660300-14	Flap Retract RH Bellcrank
1	1660300-17	Flap Retract to Lever
1	1660300-16	Flap Direct to Lever
2	MC1660300-8	Aileron Direct to Torque Tube
2	MC1660300-9	Aileron Direct to Bellcrank

Kit continues on next page

\* See pages 122-124 for Pulley Kit Components  
 1 Partial model eligibility  
 2 Included in both galvanized and stainless kits.  
 3 For S/N 18502566 thru 18503153 only



Flight Control System

Qty	P/N	Galv SS	Location
1	MC1660300-11		Aileron Carry Thru LH
1	MC1660300-10		Aileron Carry Thru RH
1	MC1660300-3		Elevator Down Forward
1	MC1660300-5		Elevator Up
1	MC1660300-4		Elevator Down Aft
1	MC1660300-6		Elevator Trim Forward Upper
1	MC1660300-7		Elevator Trim Forward Lower
1	MC0510105-187		Elevator Trim Aft Lower
1	MC0510105-198		Elevator Trim Aft Upper
1	MCS2295-25-70		Elevator Trim Chain Forward
1	MCS2295P25-71		Elevator Trim Chain Aft
4	MCS2294-25		Connecting Link
2	MC1660300-1		Rudder Forward
2	MC1660300-2		Rudder Center
2	MC0510105-152		Rudder Aft
2	MC0510105-323		Tailwheel Steering
4	MC0422280		Bellcrank Aileron Bushing

**188, A188 1968-1969**  
S/N 1880318 thru 1880572  
Complete Cable Kit P/N CCKT188-03  
Complete Pulley Kit P/N PULL-KT-42\*

Qty	P/N	Location
1	MC1660300-13	Flap Direct LH Bellcrank
1	MC1660300-12	Flap Direct RH Bellcrank
1	MC1660300-15	Flap Retract LH Bellcrank
1	MC1660300-14	Flap Retract RH Bellcrank
1	MC1660300-21	Flap Retract to Lever
1	MC1660300-20	Flap Direct to Lever
2	MC1660300-8	Aileron Direct to Torque Tube
2	MC1660300-9	Aileron Direct to Bellcrank
1	MC1660300-11	Aileron Carry Thru LH
1	MC1660300-10	Aileron Carry Thru RH
1	MC1660300-3	Elevator Down Forward
1	MC1660300-5	Elevator Up
1	MC1660300-4	Elevator Down Aft
1	MC1660300-6	Elevator Trim Forward Upper
1	MC1660300-7	Elevator Trim Forward Lower
1	MC0510105-187	Elevator Trim Aft Lower
1	MC0510105-198	Elevator Trim Aft Upper
1	MCS2295-25-70	Elevator Trim Chain Forward
1	MCS2295P25-71	Elevator Trim Chain Aft
4	MCS2294-25	Connecting Link
2	MC1660300-1	Rudder Forward
2	MC1660300-2	Rudder Center
2	MC0510105-152	Rudder Aft
2	MC0510105-323	Tailwheel Steering
1	MC1613245-2	Parking Brake Cable
4	MC0422280	Bellcrank Aileron Bushing

**188A, A188A 1970-1971**  
S/N 18800573 thru 18800707  
Complete Cable Kit P/N CCKT188-04  
Complete Pulley Kit P/N PULL-KT-43\*

Qty	P/N	Location
1	MC1660300-13	Flap Direct LH Bellcrank
1	MC1660300-12	Flap Direct RH Bellcrank
1	MC1660300-15	Flap Retract LH Bellcrank
1	MC1660300-14	Flap Retract RH Bellcrank
1	MC1660300-21	Flap Retract to Lever
1	MC1660300-20	Flap Direct to Lever
2	MC1660300-30	Aileron Direct to Torque Tube
2	MC1660300-9	Aileron Direct to Bellcrank
1	MC1660300-33	Aileron Carry Thru LH
1	MC1660300-10	Aileron Carry Thru RH
1	MC1660300-3	Elevator Down Forward
1	MC1660300-5	Elevator Up
1	MC1660300-4	Elevator Down Aft
1	MC1660300-6	Elevator Trim Forward Upper
1	MC1660300-7	Elevator Trim Forward Lower
1	MC0510105-187	Elevator Trim Aft Lower
1	MC0510105-198	Elevator Trim Aft Upper
1	MCS2295-25-70	Elevator Trim Chain Forward
1	MCS2295P25-71	Elevator Trim Chain Aft
4	MCS2294-25	Connecting Link
2	MC1660300-1	Rudder Forward
2	MC1660300-2	Rudder Center
2	MC0510105-152	Rudder Aft
2	MC0510105-323	Tailwheel Steering
1	MC1613245-2	Parking Brake Cable
4	MC0422280	Bellcrank Aileron Bushing

**188A, A188A 1970-1971**  
S/N 18800708 thru 18800832  
Complete Cable Kit P/N CCKT188-05  
Complete Pulley Kit P/N PULL-KT-44\*

Qty	P/N	Location
1	MC1660300-13	Flap Direct LH Bellcrank
1	MC1660300-12	Flap Direct RH Bellcrank
1	MC1660300-15	Flap Retract LH Bellcrank
1	MC1660300-14	Flap Retract RH Bellcrank
1	MC1660300-21	Flap Retract to Lever
1	MC1660300-20	Flap Direct to Lever
2	MC1660300-35	Aileron Direct to Torque Tube
2	MC1660300-9	Aileron Direct to Bellcrank

Kit continues in next column

Qty	P/N	Location
1	MC1660300-33	Aileron Carry Thru LH
1	MC1660300-38	Aileron Carry Thru RH
1	MC1660300-3	Elevator Down Forward
1	MC1660300-5	Elevator Up
1	MC1660300-4	Elevator Down Aft
1	MC1660300-6	Elevator Trim Forward Upper
1	MC1660300-7	Elevator Trim Forward Lower
1	MC0510105-187	Elevator Trim Aft Lower
1	MC0510105-198	Elevator Trim Aft Upper
1	MCS2295-25-70	Elevator Trim Chain Forward
1	MCS2295P25-71	Elevator Trim Chain Aft
4	MCS2294-25	Connecting Link
2	MC1660300-1	Rudder Forward
2	MC1660300-2	Rudder Center
2	MC0510105-152	Rudder Aft
2	MC0510105-323	Tailwheel Steering
1	MC1613245-2	Parking Brake Cable
4	MC0422280	Bellcrank Aileron Bushing

**188B, A188B 1972**  
S/N 18800833 thru 18800874  
Complete Cable Kit P/N CCKT188-06  
Complete Pulley Kit P/N PULL-KT-44\*

Qty	P/N	Location
1	MC1660300-13	Flap Direct LH Bellcrank
1	MC1660300-12	Flap Direct RH Bellcrank
1	MC1660300-15	Flap Retract LH Bellcrank
1	MC1660300-14	Flap Retract RH Bellcrank
1	MC1660300-21	Flap Retract to Lever
1	MC1660300-20	Flap Direct to Lever
2	MC1660300-35	Aileron Direct to Torque Tube
2	MC1660300-9	Aileron Direct to Bellcrank
1	MC1660300-33	Aileron Carry Thru LH
1	MC1660300-38	Aileron Carry Thru RH
1	MC1660300-3	Elevator Down Forward
1	MC1660300-5	Elevator Up
1	MC1660300-4	Elevator Down Aft
1	MC1660300-6	Elevator Trim Forward Upper
1	MC1660300-7	Elevator Trim Forward Lower
1	MC0510105-187	Elevator Trim Aft Lower
1	MC0510105-198	Elevator Trim Aft Upper
1	MCS2295-25-70	Elevator Trim Chain Forward
1	MCS2295P25-71	Elevator Trim Chain Aft
4	MCS2294-25	Connecting Link
2	MC1660300-1	Rudder Forward
2	MC1660300-2	Rudder Center
2	MC0510105-152	Rudder Aft
2	MC0510105-323	Tailwheel Steering
1	MC1613245-2	Parking Brake Cable
1	MC1660300-41	Deflector
4	MC0422280	Bellcrank Aileron Bushing

**188B, A188B 1972-1973**  
S/N 18800875 thru 18801374 & 967T thru 1374T  
Complete Cable Kit P/N CCKT188-07  
Complete Pulley Kit P/N PULL-KT-44\* or -45\* Note 1

Qty	P/N	Location
1	MC1660300-13	Flap Direct LH Bellcrank
1	MC1660300-12	Flap Direct RH Bellcrank
1	MC1660300-15	Flap Retract LH Bellcrank
1	MC1660300-14	Flap Retract RH Bellcrank
1	MC1660300-21	Flap Retract to Lever
1	MC1660300-20	Flap Direct to Lever
2	MC1660300-35	Aileron Direct to Torque Tube
2	MC1660300-9	Aileron Direct to Bellcrank
1	MC1660300-33	Aileron Carry Thru LH
1	MC1660300-38	Aileron Carry Thru RH
1	MC1660300-3	Elevator Down Forward
1	MC1660300-5	Elevator Up
1	MC1660300-4	Elevator Down Aft
1	MC1660300-6	Elevator Trim Forward Upper
1	MC1660300-7	Elevator Trim Forward Lower
1	MC0510105-187	Elevator Trim Aft Lower
1	MC0510105-198	Elevator Trim Aft Upper
1	MCS2295-25-70	Elevator Trim Chain Forward
1	MCS2295P25-71	Elevator Trim Chain Aft
4	MCS2294-25	Connecting Link
2	MC1660300-1	Rudder Forward
2	MC1660300-2	Rudder Center
2	MC0510105-152	Rudder Aft
2	MC0510105-323	Tailwheel Steering
1	MC1613245-2	Parking Brake Cable
1	MC1660300-41	Deflector
1	MC9861000-1	Tailwheel Lock Control
4	MC0422280	Bellcrank Aileron Bushing

Note 1: S/N 18800875 thru 18801348 USE PULL-KT-44  
S/N 18801349T thru 18801374T USE PULL-KT-44  
S/N 18801349 thru 18801374 USE PULL-KT-45

**188B, A188B 1974**  
S/N 18801375 thru 18801402 & 1375T thru 1402T  
Complete Cable Kit P/N CCKT188-08  
Complete Pulley Kit P/N PULL-KT-45\*

Qty	P/N	Location
1	MC1660300-13	Flap Direct LH Bellcrank
1	MC1660300-12	Flap Direct RH Bellcrank

Kit continues in next column

Qty	P/N	Location
1	MC1660300-15	Flap Retract LH Bellcrank
1	MC1660300-14	Flap Retract RH Bellcrank
1	MC1660300-21	Flap Retract to Lever
1	MC1660300-20	Flap Direct to Lever
2	MC1660300-35	Aileron Direct to Torque Tube
2	MC1660300-9	Aileron Direct to Bellcrank
1	MC1660300-33	Aileron Carry Thru LH
1	MC1660300-38	Aileron Carry Thru RH
1	MC1660300-3	Elevator Down Forward
1	MC1660300-5	Elevator Up
1	MC1660300-4	Elevator Down Aft
1	MC1660300-6	Elevator Trim Forward Upper
1	MC1660300-7	Elevator Trim Forward Lower
1	MC0510105-187	Elevator Trim Aft Lower
1	MC0510105-198	Elevator Trim Aft Upper
1	MCS2295-25-70	Elevator Trim Chain Forward
1	MCS2295P25-71	Elevator Trim Chain Aft
4	MCS2294-25	Connecting Link
2	MC1660300-1	Rudder Forward
2	MC1660300-2	Rudder Center
2	MC0510105-152	Rudder Aft
2	MC0510105-323	Tailwheel Steering
1	MC1613245-2	Parking Brake Cable
1	MC1660300-42	Deflector W/Flashing Beacon
1	MC1660300-43	Deflector
1	MC9861000-1	Tailwheel Lock Control
4	MC0422280	Bellcrank Aileron Bushing

**188B, A188B 1974-1975**  
S/N 18801403 thru 18802348 & 1403T thru 2348T  
Complete Cable Kit P/N CCKT188-09  
Complete Pulley Kit P/N PULL-KT-46\*

Qty	P/N	Location
1	MC1660300-13	Flap Direct LH Bellcrank
1	MC1660300-12	Flap Direct RH Bellcrank
1	MC1660300-15	Flap Retract LH Bellcrank
1	MC1660300-14	Flap Retract RH Bellcrank
1	MC1660300-21	Flap Retract to Lever
1	MC1660300-20	Flap Direct to Lever
2	MC1660300-35	Aileron Dir to Torque Tube
2	MC1660300-9	Aileron Direct to Bellcrank
1	MC1660300-33	Aileron Carry Thru LH
1	MC1660300-38	Aileron Carry Thru RH
1	MC1660300-3	Elevator Down Forward
1	MC1660300-5	Elevator Up
1	MC1660300-4	Elevator Down Aft
1	MC1660300-6	Elevator Trim Forward Upper
1	MC1660300-7	Elevator Trim Forward Lower
1	MC0510105-187	Elevator Trim Aft Lower
1	MC0510105-198	Elevator Trim Aft Upper
1	MCS2295-25-70	Elevator Trim Chain Forward
1	MCS2295P25-71	Elevator Trim Chain Aft
4	MCS2294-25	Connecting Link
2	MC1660300-1	Rudder Forward
2	MC1660300-2	Rudder Center
2	MC0510105-152	Rudder Aft
2	MC0510105-323	Tailwheel Steering
1	MC1613245-2	Parking Brake Cable
1	MC1660300-42	Deflector W/Flashing Beacon
1	MC1660300-43	Deflector
2	MC1660300-44	Parking Brake
1	MC9861000-1	Tailwheel Lock Control
4	MC0422280	Bellcrank Aileron Bushing

**A188B 1976**  
S/N 18802349 thru 18802745, 18802349T thru 18802745T  
Complete Cable Kit P/N CCKT188-10  
Complete Pulley Kit P/N PULL-KT-46\*

Qty	P/N	Location
1	MC1660300-13	Flap Direct LH Bellcrank
1	MC1660300-12	Flap Direct RH Bellcrank
1	MC1660300-15	Flap Retract LH Bellcrank
1	MC1660300-14	Flap Retract RH Bellcrank
1	MC1660300-21	Flap Retract to Lever
1	MC1660300-20	Flap Direct to Lever
2	MC1660300-35	Aileron Direct to Torque Tube
2	MC1660300-9	Aileron Direct to Bellcrank
1	MC1660300-33	Aileron Carry Thru LH
1	MC1660300-38	Aileron Carry Thru RH
1	MC1660300-3	Elevator Down Forward
1	MC1660300-5	Elevator Up
1	MC1660300-4	Elevator Down Aft
1	MC1660300-6	Elevator Trim Forward Upper
1	MC1660300-7	Elevator Trim Forward Lower
1	MC0510105-187	Elevator Trim Aft Lower
1	MC0510105-198	Elevator Trim Aft Upper
1	MCS2295-25-70	Elevator Trim Chain Forward
1	MCS2295P25-71	Elevator Trim Chain Aft
4	MCS2294-25	Connecting Link
2	MC1660300-1	Rudder Forward
2	MC1660300-2	Rudder Center
2	MC0510105-152	Rudder Aft

Kit continues on next page

\* See pages 122-124 for Pulley Kit Components  
Partial model eligibility is listed for reference only.

# Flight Control System

## Flight Control Cables - Cessna

Continued from previous page			
Qty	P/N	Galv SS	Location
2	MC0510105-323		Tailwheel Steering
1	MC1613245-2		Parking Brake Cable
1	MC9861000-1		Tailwheel Lock Control
4	MC0422280		Bellcrank Aileron Bushing

**A188B1 1977-1978**  
S/N 18802746 thru 18803296, 18802746T thru 18803296T  
Complete Cable Kit P/N CCKT188-11  
Complete Pulley Kit P/N PULL-KT-46\*

Qty	P/N	Galv SS	Location
1	MC1660300-13		Flap Direct LH Bellcrank
1	MC1660300-12		Flap Direct RH Bellcrank
1	MC1660300-15		Flap Retract LH Bellcrank
1	MC1660300-14		Flap Retract RH Bellcrank
1	1660300-47 <sup>7</sup>		Flap Retract to Lever
1	1660300-46 <sup>7</sup>		Flap Direct to Lever
2	MC1660300-35		Aileron Direct to Torque Tube
2	MC1660300-9		Aileron Direct to Bellcrank
1	MC1660300-33		Aileron Carry Thru LH
1	MC1660300-38		Aileron Carry Thru RH
1	MC1660300-3		Elevator Down Forward
1	MC1660300-5		Elevator Up
1	MC1660300-4		Elevator Down Aft
1	MC1660300-6		Elevator Trim Forward Upper
1	MC1660300-7		Elevator Trim Forward Lower
1	MC0510105-187		Elevator Trim Aft Lower
1	MC0510105-198		Elevator Trim Aft Upper
1	MCS2295-25-70		Elevator Trim Chain Forward
1	MCS2295P25-71		Elevator Trim Chain Aft
4	MCS2294-25		Connecting Link
2	MC1660300-1		Rudder Forward
2	MC1660300-2		Rudder Center
2	MC0510105-152		Rudder Aft
2	MC0760135-106		Tailwheel Steering
1	MC1613245-2		Parking Brake Cable
1	MC9861000-1		Tailwheel Lock Control
4	MC0422280		Bellcrank Aileron Bushing

**A188B1 T188C 1979**  
S/N 18803297 thru 18803521, 18803297T thru 18803521T,  
T18803297T thru T18803521T  
Complete Cable Kit P/N CCKT188-12  
Complete Pulley Kit P/N PULL-KT-46\*

Qty	P/N	Galv SS	Location
1	MC1660300-13		Flap Direct LH Bellcrank
1	MC1660300-12		Flap Direct RH Bellcrank
1	MC1660300-15		Flap Retract LH Bellcrank
1	MC1660300-14		Flap Retract RH Bellcrank
1	1660300-47 <sup>7</sup>		Flap Retract to Lever
1	1660300-46 <sup>7</sup>		Flap Direct to Lever
2	MC1660300-35		Aileron Direct to Torque Tube
2	MC1660300-9		Aileron Direct to Bellcrank
1	MC1660300-33		Aileron Carry Thru LH
1	MC1660300-38		Aileron Carry Thru RH
1	MC1660300-3		Elevator Down Forward
1	MC1660300-5		Elevator Up
1	MC1660300-4		Elevator Down Aft
1	MC1660300-6		Elevator Trim Forward Upper
1	MC1660300-7		Elevator Trim Forward Lower
1	MC0510105-187		Elevator Trim Aft Lower
1	MC0510105-198		Elevator Trim Aft Upper
1	MCS2295-25-70		Elevator Trim Chain Forward
1	MCS2295P25-71		Elevator Trim Chain Aft
4	MCS2294-25		Connecting Link
2	MC1660300-1		Rudder Forward
2	MC1660300-2		Rudder Center
2	MC0510105-152		Rudder Aft
2	MC0760135-106		Tailwheel Steering
1	MC1613245-2		Parking Brake Cable
1	MC9861000-1		Tailwheel Lock Control
1	MC1660300-48		Deflector
4	MC0422280		Bellcrank Aileron Bushing

**A188B1 T188C 1980-1983**  
S/N 18803522 thru 18803856, 18803522T thru 18803968T,  
T18803522T thru T18803968T  
Complete Cable Kit P/N CCKT188-13  
Complete Pulley Kit P/N PULL-KT-46\*

Qty	P/N	Galv SS	Location
1	MC1660300-13		Flap Direct LH Bellcrank
1	MC1660300-12		Flap Direct RH Bellcrank
1	MC1660300-15		Flap Retract LH Bellcrank
1	MC1660300-14		Flap Retract RH Bellcrank
1	1660300-47 <sup>7</sup>		Flap Retract to Lever
1	1660300-46 <sup>7</sup>		Flap Direct to Lever
2	MC1660300-35		Aileron Direct to Torque Tube
2	MC1660300-9		Aileron Direct to Bellcrank
1	MC1660300-33		Aileron Carry Thru LH
1	MC1660300-38		Aileron Carry Thru RH
1	MC1660300-3		Elevator Down Forward
1	MC1660300-5		Elevator Up
1	MC1660300-4		Elevator Down Aft
1	MC1660300-6		Elevator Trim Forward Upper
1	MC1660300-7		Elevator Trim Forward Lower
1	MC0510105-187		Elevator Trim Aft Lower

**Kit continues in next column**

Continued from previous column			
Qty	P/N	Galv SS	Location
1	MC0510105-198		Elevator Trim Aft Upper
1	MCS2295-25-70		Elevator Trim Chain Forward
1	MCS2295P25-71		Elevator Trim Chain Aft
4	MCS2294-25		Connecting Link
2	MC1660300-1		Rudder Forward
2	MC1660300-2		Rudder Center
2	MC0510105-152		Rudder Aft
2	MC0760135-106		Tailwheel Steering
1	MC1613245-2		Parking Brake Cable
1	MC9861000-1		Tailwheel Lock Control
4	MC0422280		Bellcrank Aileron Bushing

**210-5 (205) 19631**  
S/N 205-0001 thru 205-0050  
Complete Cable Kit P/N CCKT205-01G (Galvanized)  
Complete Cable Kit P/N CCKT205-01S (Stainless Steel)  
Complete Pulley Kit P/N PULL-KT-47\*

Qty	P/N	Galv SS	Location
1	MC1260505-1 or 101		Park Brake
1	MC1260417-1 or 2		Park Brake Cable & Tube
2	MC1260505-3 or 103		Aileron Direct
1	MC0510105-13 or 113		Aileron Carry Thru
1	MC1260505-18 or 118		Elevator Down
1	MC1260505-19 or 119		Elevator Up
1	MC1260505-2 or 102		Elevator Down Spring
1	MCS2295-25-185		Chain Elevator Trim Fwd Low
1	MCS2295A25-111		Chain Elevator Trim Fwd Up
1	MC1260505-16 or 116		Elevator Trim Forward LH
1	MC1260505-17 or 117		Elevator Trim Forward RH
1	MC1260505-8 or 108		Elevator Trim Aft LH
1	MC1260505-7 or 107		Elevator Trim Aft RH
1	MC0510105-93 or 193 <sup>6</sup>		Flap Retract
1	MC0510105-91 or 191		Flap Direct RH
1	MC0510105-94 or 194 <sup>6</sup>		Flap Retract
1	MC0510105-92 or 192		Flap Direct RH
1	MC0510105-203 or 303		Rudder Forward LH
1	MC0510105-204 or 304		Rudder Forward RH
1	MC1260505-13 or 113		Rudder Aft LH
1	MC1260505-12 or 112		Rudder Aft RH
1	MCS2295P25-113 <sup>10</sup>		Chain Elevator Trim Actuator
6	MCS2294-25		Chain Connecting Link
4	MC0422280		Bellcrank Aileron Bushing

**210-5 (205) 1 210-5A (205A) 19631-1964**  
S/N 205-0051 thru 205-0577  
Complete Cable Kit P/N CCKT205-02G (Galvanized)  
Complete Cable Kit P/N CCKT205-02S (Stainless Steel)  
Complete Pulley Kit P/N PULL-KT-47\*

Qty	P/N	Galv SS	Location
1	MC1260505-1 or 101		Park Brake
1	MC1260417-1 or 2		Park Brake Cable & Tube
2	MC1260505-3 or 103		Aileron Direct
1	MC0510105-13 or 113		Aileron Carry Thru
1	MC1260505-18 or 118		Elevator Down
1	MC1260505-19 or 119		Elevator Up
1	MC1260505-2 or 102		Elevator Down Spring
1	MCS2295-25-185		Chain Elevator Trim Fwd Low
1	MCS2295A25-111		Chain Elevator Trim Fwd Up
1	MC1260505-16 or 116		Elevator Trim Forward LH
1	MC1260505-17 or 117		Elevator Trim Forward RH
1	MC1260505-8 or 108		Elevator Trim Aft LH
1	MC1260505-7 or 107		Elevator Trim Aft RH
1	MC0510105-93 or 193 <sup>6</sup>		Flap Retract
1	MC0510105-91 or 191		Flap Direct RH
1	MC0510105-94 or 194 <sup>6</sup>		Flap Retract
1	MC0510105-92 or 192		Flap Direct RH
1	MC0510105-203 or 303		Rudder Forward LH
1	MC0510105-204 or 304		Rudder Forward RH
1	MC1260505-13 or 113		Rudder Aft LH
1	MC1260505-12 or 112		Rudder Aft RH
1	MCS2295P25-113 <sup>10</sup>		Chain Elevator Trim Actuator
6	MCS2294-25		Chain Connecting Link
4	MC0422280		Bellcrank Aileron Bushing

**206, U206, A, B, TU206A, B 1964-1967**  
**P206, P206A, B, TP206A, B 1964-1967**  
S/N 206-0001 thru U206-0914, P206-0001 thru P206-0419  
Complete Cable Kit P/N CCKT206-01G (Galvanized)  
Complete Cable Kit P/N CCKT206-01S (Stainless Steel)  
Complete Pulley Kit P/N PULL-KT-48\*

Qty	P/N	Galv SS	Location
1	MC1260417-1 or 2		Park Brake
1	MC1260505-1 or 101		Park Brake
1	MC1260505-29 or 129		Elevator Down Forward
1	MC1260505-30 or 130		Elevator Up Forward
1	MC1260505-28 or 128		Elevator Down Spring
1	MCS2295A25-111		Chain Elevator Trim Fwd Up
1	MCS2295-25-185		Chain Elevator Trim Fwd Low
1	MC1260505-16 or 116		Elevator Trim Forward LH
1	MC1260505-17 or 117		Elevator Trim Forward RH
1	MC1260505-8 or 108		Elevator Trim Aft LH
1	MC1260505-7 or 107		Elevator Trim Aft RH
2	MC1260505-25 or 125		Aileron Direct
2	MC1260505-26 or 126		Aileron Direct Outboard
1	MC1260505-23 or 123		Aileron Carry Thru LH

**Kit continues in next column**

Continued from previous column			
Qty	P/N	Galv SS	Location
1	MC1260505-27 or 127		Aileron Carry Thru RH
1	MC0510105-93 or 193 <sup>6</sup>		Flap Retract
1	MC0510105-94 or 194 <sup>6</sup>		Flap Retract
1	MC0510105-91 or 191		Flap Direct LH
1	MC0510105-92 or 192		Flap Direct RH
1	MC0510105-203 or 303		Rudder Forward LH
1	MC0510105-204 or 304		Rudder Forward RH
1	MC1260505-12 or 112		Rudder Aft LH
1	MC1260505-13 or 113		Rudder Aft RH
1	MCS2295P25-113 <sup>10</sup>		Chain Elevator Trim Actuator
6	MCS2294-25		Chain Connecting Link

*Available separately for aircraft with camera option*

**U206D, E, TU206D, E 1968-1969**  
**P206D, E, TP206D, E 1968-1969**  
S/N U206-0915 thru U206-1345, P206-0420 thru P206-0583  
Complete Cable Kit P/N CCKT206-02G (Galvanized)  
Complete Cable Kit P/N CCKT206-02S (Stainless Steel)  
Complete Cable Kit P/N CCKT206-02GE (Galv. Elec. Trim)  
Complete Cable Kit P/N CCKT206-02SE (SS Electric Trim)  
Complete Pulley Kit P/N PULL-KT-49\*

Qty	P/N	Galv SS	Location
1	MC1260505-1 or 101		Park Brake
1	MC1260417-1 or 2		Park Brake Cable and Tube
1	MC1260505-29 or 129		Elevator Down Forward
1	MC1260505-30 or 130		Elevator Up Forward
1	MC1260505-53 or 153		Elevator Down Spring
1	MCS2295A25-111		Chain Elevator Trim Fwd Up
1	MCS2295-25-185		Chain Elevator Trim Fwd Low
1	MC1260505-16 or 116		Elevator Trim Forward LH
1	MC1260505-17 or 117		Elevator Trim Forward RH
1	MC1260505-46 or 146		Elevator Trim Aft LH
1	MC1260505-45 or 145		Elevator Trim Aft RH
1	MC1260078-8 or 108		Aileron Yoke RH
1	MC1260078-7 or 107		Aileron Yoke LH
1	MC1260078-5 or 105		Aileron Yoke Primary
2	MC1260505-55 or 155		Aileron Direct Inboard
2	MC1260505-58 or 158		Aileron Direct Outboard
2	MC1260505-60 or 160		Aileron Carry Thru LH
1	MC1260505-54 or 154		Aileron Carry Thru RH
1	MC1260505-168 or 168		Elevator Trim Center LH
1	MC1260505-64 or 164		Elevator Trim Center RH
1	MC1260505-63 or 163		Elevator Trim Forward LH
1	MC1260505-69 or 169		Elevator Trim Aft RH
1	MC1260505-57 or 157		Elevator Trim Aft LH
1	MC0510105-93 or 193 <sup>6</sup>		Flap Retract
1	MC0510105-94 or 194 <sup>6</sup>		Flap Retract
1	MC0510105-91 or 191		Flap Direct LH
1	MC0510105-92 or 192		Flap Direct RH
1	MC0510105-203 or 303		Rudder Forward LH
1	MC0510105-204 or 304		Rudder Forward RH
1	MC1260505-12 or 112		Rudder Aft LH
1	MC1260505-13 or 113		Rudder Aft RH
1	MCS2295P25-113 <sup>10</sup>		Chain Elevator Trim Actuator
6	MCS2294-25		Chain Connecting Link

*Available separately for aircraft with camera option*

**U206D, E, TU206D, E 1965-1971**  
**P206D, E, TP206D, E 1965-1971**  
S/N U206-1346 thru U20601667, P206-0584 thru P20600647  
Complete Cable Kit P/N CCKT206-03G (Galvanized)  
Complete Cable Kit P/N CCKT206-03S (Stainless Steel)  
Complete Cable Kit P/N CCKT206-03GE (Galv. Elec. Trim)  
Complete Cable Kit P/N CCKT206-03SE (SS Electric Trim)  
Complete Pulley Kit P/N PULL-KT-49\*

Qty	P/N	Galv SS	Location
1	MC1260505-1 or 101		Park Brake
1	MC1260417-1 or 2		Park Brake Cable & Tube
1	MC1260505-29 or 129		Elevator Down Forward



# Flight Control System

## Flight Control Cables - Cessna

Continued from previous page

Qty	P/N	Galv	SS	Location
1	MC1260078-5 or 105			Aileron Yoke Primary
1	MC1260078-7 or 107			Aileron Yoke LH
1	MC1260078-8 or 108			Aileron Yoke RH
2	MC1260505-55 or 155			Aileron Direct Inboard
2	MC1260505-58 or 158			Aileron Direct Outboard
1	MC1260505-60 or 160			Aileron Carry Thru LH
1	MC1260505-54 or 154			Aileron Carry Thru RH
1	MC0510105-93 or 193	6		Flap Retract
1	MC0510105-94 or 194	6		Flap Retract
1	MC0510105-259 or 359			Flap Direct LH
1	MC0510105-92 or 192			Flap Direct RH
1	MC0510105-203 or 303			Rudder Forward LH
1	MC0510105-204 or 304			Rudder Forward RH
1	MC1260505-12 or 112			Rudder Aft RH
1	MC1260505-13 or 113			Rudder Aft LH
6	MCS2294-25			Chain Connecting Link

Available separately for aircraft with camera option

1	MC1260105-118	2		Rudder Aft LH with Camera
---	---------------	---	--	---------------------------

Note 1:  
S/N U20602580 thru U20603798 USE PULL-KT-54  
S/N U20603799 thru U20605919 USE PULL-KT-55

**U206G1, TU206G1 1981**  
S/N U20605920 thru U20606003  
Complete Cable Kit P/N CCTK206-11G (Galvanized)  
Complete Cable Kit P/N CCTK206-11S (Stainless Steel)  
Complete Pulley Kit P/N PULL-KT-55\*

Qty	P/N	Galv	SS	Location
1	MC1260505-317 or 417			Park Brake
1	MC1260417-6 or 7			Park Brake Cable & Tube
2	MC1260505-306 or 406			Elevator Control
1	MCS2295A25-111			Chain Elevator Trim Fwd Up
1	MCS2295-25-185			Chain Elevator Trim Fwd Low
1	MCS2295-25-47			Chain Elevator Trim Actuator
1	MC1260505-95 or 195			Elevator Trim Forward LH
1	MC1260505-98 or 198			Elevator Trim Forward RH
1	MC1260505-46 or 146			Elevator Trim Aft LH
1	MC1260505-99 or 199			Elevator Trim Aft RH
1	MC1260078-5 or 105			Aileron Yoke Primary
1	MC1260078-7 or 107			Aileron Yoke LH
1	MC1260078-8 or 108			Aileron Yoke RH
2	MC1260505-55 or 155			Aileron Direct Inboard
2	MC1260505-58 or 158			Aileron Direct Outboard
1	MC1260505-60 or 160			Aileron Carry Thru LH
1	MC1260505-54 or 154			Aileron Carry Thru RH
1	MC0510105-93 or 193	6		Flap Retract
1	MC0510105-94 or 194	6		Flap Retract
1	MC0510105-259 or 359			Flap Direct LH
1	MC0510105-92 or 192			Flap Direct RH
1	MC0510105-203 or 303			Rudder Forward LH
1	MC0510105-204 or 304			Rudder Forward RH
1	MC1260505-12 or 112			Rudder Aft RH
1	MC1260505-13 or 113			Rudder Aft LH
6	MCS2294-25			Chain Connecting Link

Available separately for aircraft with camera option

1	MC1260105-118	2		Rudder Aft LH with Camera
---	---------------	---	--	---------------------------

**U206G1, TU206G1 1981**  
S/N U20606004 thru U20606439  
Complete Cable Kit P/N CCTK206-12G (Galvanized)  
Complete Cable Kit P/N CCTK206-12S (Stainless Steel)  
Complete Pulley Kit P/N PULL-KT-55\*

Qty	P/N	Galv	SS	Location
1	MC1260505-317 or 417			Park Brake
1	MC1260417-6 or 7			Park Brake Cable & Tube
2	MC1260505-306 or 406			Elevator Control
1	MCS2295A25-111			Chain Elevator Trim Fwd Up
1	MCS2295-25-185			Chain Elevator Trim Fwd Low
1	MCS2295-25-47			Chain Elevator Trim Actuator
1	MC1260505-95 or 195			Elevator Trim Forward LH
1	MC1260505-98 or 198			Elevator Trim Forward RH
1	MC1260505-46 or 146			Elevator Trim Aft LH
1	MC1260505-99 or 199			Elevator Trim Aft RH
1	MC1260078-5 or 105			Aileron Yoke Primary
1	MC1260078-7 or 107			Aileron Yoke LH
1	MC1260078-8 or 108			Aileron Yoke RH
2	MC1260505-55 or 155			Aileron Direct Inboard
2	MC1260505-58 or 158			Aileron Direct Outboard
1	MC1260505-60 or 160			Aileron Carry Thru LH
1	MC1260505-54 or 154			Aileron Carry Thru RH
1	MC0510105-93 or 193	6		Flap Retract
1	MC0510105-94 or 194	6		Flap Retract
1	MC0510105-259 or 359			Flap Direct LH
1	MC0510105-92 or 192			Flap Direct RH
1	MC0510105-203 or 303			Rudder Forward LH
1	MC0510105-204 or 304			Rudder Forward RH
1	MC1260505-12 or 112			Rudder Aft RH
1	MC1260505-13 or 113			Rudder Aft LH
6	MCS2294-25			Chain Connecting Link

Available separately for aircraft with camera option

1	MC1260105-118	2		Rudder Aft LH with Camera
---	---------------	---	--	---------------------------

**U206G, TU206G 1982-1986**  
S/N U20606440 thru U20607020  
Complete Cable Kit P/N CCTK206-13G (Galvanized)  
Complete Cable Kit P/N CCTK206-13S (Stainless Steel)  
Complete Pulley Kit P/N PULL-KT-55\*

Qty	P/N	Galv	SS	Location
1	MC1260505-317 or 417			Park Brake
1	MC1260417-6 or 7			Park Brake Cable & Tube
2	MC1260505-306 or 406			Elevator Control
1	MCS2295A25-111			Chain Elevator Trim Fwd Up
1	MCS2295-25-185			Chain Elevator Trim Fwd Low
1	MCS2295-25-47			Chain Elevator Trim Actuator
1	MC1260505-95 or 195			Elevator Trim Forward LH
1	MC1260505-98 or 198			Elevator Trim Forward RH
1	MC1260505-46 or 146			Elevator Trim Aft LH
1	MC1260505-99 or 199			Elevator Trim Aft RH
1	MC1260078-12 or 112			Aileron Yoke RH
1	MC1260078-11 or 111			Aileron Yoke LH
1	MC1260078-10 or 110			Aileron Yoke Primary
2	MC1260505-320 or 420			Aileron Direct
2	MC1260505-58 or 158			Aileron Direct Outboard
1	MC1260505-60 or 160			Aileron Carry Thru LH
1	MC1260505-54 or 154			Aileron Carry Thru RH
1	MC0510105-93 or 193	6		Flap Retract
1	MC0510105-94 or 194	6		Flap Retract
1	MC0510105-259 or 359			Flap Direct LH
1	MC0510105-92 or 192			Flap Direct RH
1	MC0510105-203 or 303			Rudder Forward LH
1	MC0510105-204 or 304			Rudder Forward RH
1	MC1260505-12 or 112			Rudder Aft RH
1	MC1260505-319 or 419			Rudder Aft LH
6	MCS2294-25			Chain Connecting Link

Available separately for aircraft with camera option

1	MC1260105-118	2		Rudder Aft LH with Camera
---	---------------	---	--	---------------------------

**206H, T206H 1998 & On**  
S/N 20608001 and T20608001 & On  
Complete Cable Kit P/N CCTK206H-01G (Galvanized)  
Complete Cable Kit P/N CCTK206H-01S (Stainless Steel)  
Complete Pulley Kit P/N PULL-KT-56\*

Qty	P/N	Galv	SS	Location
1	MC1260505-97	2		Park Brake
1	MC1260417-6 or 7			Park Brake Cable & Tube
2	MC1260505-306 or 406			Elevator Control
1	MC1260505-46 or 146			Elevator Trim Aft LH
1	MC1260505-95 or 195			Elevator Trim Forward LH
1	MC1260505-98 or 198			Elevator Trim Forward RH
1	MC1260505-99 or 199			Elevator Trim Aft RH
1	MC1260078-10 or 110			Aileron Yoke Primary
1	MC1260078-11 or 111			Aileron Yoke LH
1	MC1260078-12 or 112			Aileron Yoke RH
1	MC1260505-54 or 154			Aileron Carry Thru RH
2	MC1260505-58 or 158			Aileron Direct Outboard
1	MC1260505-60 or 160			Aileron Carry Thru LH
2	MC1260505-320 or 420			Aileron Direct
1	MC1260505-12 or 112			Rudder Aft RH
1	MC1260505-319 or 419			Rudder Aft LH
1	MC0510105-203 or 303			Rudder Forward LH
1	MC0510105-204 or 304			Rudder Forward RH
1	MC0510105-93 or 193	6		Flap Retract
1	MC0510105-94 or 194	6		Flap Retract
1	MC0510105-92 or 192			Flap Direct RH
1	MC0510105-259 or 359			Flap Direct LH
1	MCS2295A25-111			Chain Elevator Trim Fwd Up
1	MCS2295P25-185			Chain Elevator Trim Fwd Low
1	MCS2295P25-47			Chain Elevator Trim Actuator
6	MCS2294-25			Chain Connecting Link

**207, T207 1969**  
S/N 20700001 thru 20700101  
Complete Cable Kit P/N CCTK207-01G (Galvanized)  
Complete Cable Kit P/N CCTK207-01S (Stainless Steel)  
Complete Cable Kit P/N CCTK207-01GE (Galv. Elec. Trim)  
Complete Cable Kit P/N CCTK207-01SE (SS Electric Trim)  
Complete Pulley Kit P/N PULL-KT-57\*

Qty	P/N	Galv	SS	Location
1	MC1260505-1 or 101			Park Brake
1	MC1260417-1 or 2			Park Brake Cable & Tube
1	MC1260078-8 or 108			Aileron Yoke RH
1	MC1260078-7 or 107			Aileron Yoke LH
1	MC1260078-5 or 105			Aileron Yoke Primary
2	MC1260505-55 or 155			Aileron Direct Inboard
2	MC1260505-58 or 158			Aileron Direct Outboard
1	MC1260505-60 or 160			Aileron Carry Thru LH
1	MC1260505-54 or 154			Aileron Carry Thru RH
1	MC1260505-78 or 178			Elevator Down Aft
1	MC1260505-75 or 175			Elevator Up Aft
1	MC1260505-129	2		Elevator Down Forward
1	MC1260505-130	2		Elevator Up Forward
1	MC1260505-303 or 403			Elevator Down Spring
1	MCS2295A25-111			Chain Elevator Trim Fwd Up
1	MCS2295-25-43			Chain Elevator Trim Actuator
1	MCS2295P25-185			Chain Elevator Trim Fwd Low
6	MCS2294-25			Chain Connecting Link
1	MC1260505-77 or 177			Elevator Trim Forward LH
1	MC1260505-76 or 176			Elevator Trim Forward RH
1	MC1260505-46 or 146			Elevator Trim Aft LH

Kit continues in next column

Continued from previous column

Qty	P/N	Galv	SS	Location
1	MC1260505-45 or 145			Elevator Trim Aft RH
1	MC0510105-93 or 193	6		Flap Retract
1	MC0510105-94 or 194	6		Flap Retract
1	MC0510105-259 or 359			Flap Direct LH
1	MC0510105-92 or 192			Flap Direct RH
1	MC0510105-229 or 329			Rudder Forward LH
1	MC0510105-230 or 330			Rudder Forward RH
1	MC1260505-13 or 113			Rudder Aft LH
1	MC1260505-12 or 112			Rudder Aft RH
1	MC1260204-3	2		Elec Elevator Trim LH
1	MC1260505-90 or 190			Elec Elevator Trim Fwd RH
1	MC1260505-85 or 185			Elec Elevator Trim Fwd LH
1	MC1260505-57 or 157			Electric Trim Aft RH
1	MC1260505-69 or 169			Electric Trim Aft LH

Available separately for aircraft with camera option

1	MC1260505-83 or 183			Rudder RH with Camera
1	MC1260505-84 or 184			Rudder LH with Camera
1	MC1260505-89 or 189			Elevator Up with Camera
1	MC1260505-88 or 188			Elevator Down with Camera
1	MC1260505-79 or 179			Elevator Trim RH with Camera
1	MC1260505-80 or 180			Elevator Trim LH with Camera

**207, T207 1969**  
S/N 20700102 thru 20700204  
Complete Cable Kit P/N CCTK207-02G (Galvanized)  
Complete Cable Kit P/N CCTK207-02S (Stainless Steel)  
Complete Cable Kit P/N CCTK207-02GE (Galv. Elec. Trim)  
Complete Cable Kit P/N CCTK207-02SE (SS Electric Trim)  
Complete Pulley Kit P/N PULL-KT-57\*

Qty	P/N	Galv	SS	Location
1	MC1260505-1 or 101			Park Brake
1	MC1260417-1 or 2			Park Brake Cable & Tube
1	MC1260078-8 or 108			Aileron Yoke RH
1	MC1260078-7 or 107			Aileron Yoke LH
1	MC1260078-5 or 105			Aileron Yoke Primary
2	MC1260505-55 or 155			Aileron Direct Inboard
2	MC1260505-58 or 158			Aileron Direct Outboard
1	MC1260505-60 or 160			Aileron Carry Thru LH
1	MC1260505-54 or 154			Aileron Carry Thru RH
1	MC1260505-78 or 178			Elevator Down
1	MC1260505-75 or 175			Elevator Up
1	MC1260505-129	2		Elevator Down Forward
1	MC1260505-130	2		Elevator Up Forward
1	MC1260505-303 or 403			Elevator Down Spring
1	MCS2295A25-111			Chain Elevator Trim Fwd Up
1	MCS2295P25-185			Chain Elevator Trim Fwd Low
1	MCS2295P25-47			Chain Elevator Trim Actuator
6	MCS2294-25			Chain Connecting Link
1	MC1260505-94 or 194			Elevator Trim Forward LH
1	MC1260505-93 or 193			Elevator Trim Forward RH
1	MC1260505-46 or 146			Elevator Trim Aft LH
1	MC1260505-91 or 191			Elevator Trim Aft RH
1	MC0510105-93 or 193	6		Flap Retract
1	MC0510105-94 or 194	6		Flap Retract
1	MC0510105-259 or 359			Flap Direct LH
1	MC0510105-92 or 192			Flap Direct RH
1	MC0510105-229 or 329			Rudder Forward LH
1	MC0510105-230 or 330			Rudder Forward RH
1	MC1260505-13 or 113			Rudder Aft LH
1	MC1260505-12 or 112			Rudder Aft RH
1	MC1260204-3	2		Electric Trim LH
1	MC1260505-90 or 190			Electric Trim Forward RH
1	MC1260505-85 or 185			Electric Trim Forward LH
1	MC1260505-57 or 157			Electric Trim Aft RH
1	MC1260505-69 or 169			Electric Trim Aft LH

Available separately for aircraft with camera option

1	MC1260505-83 or 183			Rudder RH with Camera
1	MC1260505-84 or 184			Rudder LH with Camera
1	MC1260505-89 or 189			Elevator Up with Camera
1	MC1260505-88 or 188			Elevator Down with Camera
1	MC1260505-79 or 179			Elevator Trim RH with Camera
1	MC1260505-80 or 180			Elevator Trim LH with Camera

**207, T207 1969-1972**  
S/N 20700205 thru 20700207  
Complete Cable Kit P/N CCTK207-03G (Galvanized)  
Complete Cable Kit P/N CCTK207-03S (Stainless Steel)  
Complete Cable Kit P/N CCTK207-03GE (Galv. Elec.



FAA-PMA Approved

Continued from previous page

Qty	P/N	Galv	SS	Location
1	MC1260505-60 or 160			Aileron Carry Thru LH
1	MC1260505-54 or 154			Aileron Carry Thru RH
1	MC1260505-78 or 178			Elevator Down Aft
1	MC1260505-75 or 175			Elevator Up Aft
1	MC1260505-129 <sup>2</sup>			Elevator Down Forward
1	MC1260505-130 <sup>2</sup>			Elevator Up Forward
1	MC1260505-303 or 403			Elevator Down Spring
1	MCS2295A25-111			Chain Elevator Trim Fwd Up
1	MCS2295P25-185			Chain Elevator Trim Fwd Low
1	MCS2295P25-47			Chain Elevator Trim Actuator
6	MCS2294-25			Chain Connecting Link
1	MC1260505-94 or 194			Elevator Trim Forward LH <sup>3</sup>
1	MC1260505-93 or 193			Elevator Trim Forward RH <sup>3</sup>
1	MC1260505-46 or 146			Elevator Trim Aft LH <sup>8</sup>
1	MC1260505-91 or 191			Elevator Trim Aft RH <sup>8</sup>
1	MC0510105-93 or 193 <sup>6</sup>			Flap Retract
1	MC0510105-94 or 194 <sup>6</sup>			Flap Retract
1	MC0510105-259 or 359			Flap Direct LH
1	MC0510105-92 or 192			Flap Direct RH
1	MC0510105-229 or 329			Rudder Forward LH
1	MC0510105-230 or 330			Rudder Forward RH
1	MC1260505-13 or 113			Rudder Aft LH
1	MC1260505-12 or 112			Rudder Aft RH
1	MC1260204-3 <sup>2</sup>			Electric Trim LH <sup>9</sup>
1	MC1260505-90 or 190			Electric Trim Forward RH <sup>9</sup>
1	MC1260505-85 or 185			Electric Trim Forward LH <sup>9</sup>
1	MC1260505-57 or 157			Electric Trim Aft RH <sup>9</sup>
1	MC1260505-69 or 169			Electric Trim Aft LH <sup>9</sup>

Available separately for aircraft with camera option

1	MC1260505-83 or 183			Rudder RH with Camera
1	MC1260505-84 or 184			Rudder LH with Camera
1	MC1260505-89 or 189			Elevator Up with Camera
1	MC1260505-88 or 188			Elevator Down with Camera
1	MC1260505-79 or 179			Elevator Trim RH with Camera
1	MC1260505-80 or 180			Elevator Trim LH with Camera

**207, T207, 1972, 1971-1973**  
 S/N 20700208 thru 20700227  
 Complete Cable Kit P/N CCTK207-04G (Galvanized)  
 Complete Cable Kit P/N CCTK207-04S (Stainless Steel)  
 Complete Cable Kit P/N CCTK207-04GE (Galv. Elec. Trim)  
 Complete Cable Kit P/N CCTK207-04SE (SS Electric Trim)  
 Complete Pulley Kit P/N PULL-KT-58\*

Qty	P/N	Galv	SS	Location
1	MC1260505-97 or 197			Park Brake
1	MC1260417-6 or 7			Park Brake Cable & Tube
1	MC1260078-8 or 108			Aileron Yoke RH
1	MC1260078-7 or 107			Aileron Yoke LH
1	MC1260078-5 or 105			Aileron Yoke Primary
2	MC1260505-55 or 155			Aileron Direct Inboard
2	MC1260505-58 or 158			Aileron Direct Outboard
1	MC1260505-60 or 160			Aileron Carry Thru LH
1	MC1260505-54 or 154			Aileron Carry Thru RH
1	MC1260505-78 or 178			Elevator Down Aft
1	MC1260505-75 or 175			Elevator Up Aft
1	MC1260505-129 <sup>2</sup>			Elevator Down Forward
1	MC1260505-130 <sup>2</sup>			Elevator Up Forward
1	MC1260505-303 or 403			Elevator Down Spring
1	MCS2295A25-111			Chain Elevator Trim Fwd Up
1	MCS2295P25-185			Chain Elevator Trim Fwd Low
1	MCS2295P25-47			Chain Elevator Trim Actuator
6	MCS2294-25			Chain Connecting Link
1	MC1260505-94 or 194			Elevator Trim Forward LH <sup>3</sup>
1	MC1260505-93 or 193			Elevator Trim Forward RH <sup>3</sup>
1	MC1260505-46 or 146			Elevator Trim Aft LH <sup>8</sup>
1	MC1260505-91 or 191			Elevator Trim Aft RH <sup>8</sup>
1	MC0510105-93 or 193 <sup>6</sup>			Flap Retract
1	MC0510105-94 or 194 <sup>6</sup>			Flap Retract
1	MC0510105-259 or 359			Flap Direct LH
1	MC0510105-92 or 192			Flap Direct RH
1	MC0510105-229 or 329			Rudder Forward LH
1	MC0510105-230 or 330			Rudder Forward RH
1	MC1260505-13 or 113			Rudder Aft LH
1	MC1260505-12 or 112			Rudder Aft RH
1	MC1260204-3 <sup>2</sup>			Electric Trim LH <sup>9</sup>
1	MC1260505-90 or 190			Electric Trim Forward RH <sup>9</sup>
1	MC1260505-85 or 185			Electric Trim Forward LH <sup>9</sup>
1	MC1260505-57 or 157			Electric Trim Aft RH <sup>9</sup>
1	MC1260505-69 or 169			Electric Trim Aft LH <sup>9</sup>

Available separately for aircraft with camera option

1	MC1260505-83 or 183			Rudder RH with Camera
1	MC1260505-84 or 184			Rudder LH with Camera
1	MC1260505-89 or 189			Elevator Up with Camera
1	MC1260505-88 or 188			Elevator Down with Camera
1	MC1260505-79 or 179			Elevator Trim RH with Camera
1	MC1260505-80 or 180			Elevator Trim LH with Camera

**207, T207 1974**  
 S/N 20700228 thru 20700267  
 Complete Cable Kit P/N CCTK207-05G (Galvanized)  
 Complete Cable Kit P/N CCTK207-05S (Stainless Steel)  
 Complete Pulley Kit P/N PULL-KT-59\*

Qty	P/N	Galv	SS	Location
1	MC1260505-97 or 197			Park Brake
1	MC1260417-6 or 7			Park Brake Cable & Tube

Continued from previous column

Qty	P/N	Galv	SS	Location
1	MC1260078-8 or 108			Aileron Yoke RH
1	MC1260078-7 or 107			Aileron Yoke LH
1	MC1260078-5 or 105			Aileron Yoke Primary
2	MC1260505-55 or 155			Aileron Direct Inboard
2	MC1260505-58 or 158			Aileron Direct Outboard
1	MC1260505-60 or 160			Aileron Carry Thru LH
1	MC1260505-54 or 154			Aileron Carry Thru RH
1	MC1260505-78 or 178			Elevator Down Aft
1	MC1260505-75 or 175			Elevator Up Aft
1	MC1260505-129 or 129			Elevator Down Forward
1	MC1260505-130 or 130			Elevator Up Forward
1	MC1260505-303 or 403			Elevator Down Spring
1	MCS2295A25-111			Chain Elevator Trim Fwd Up
1	MCS2295P25-185			Chain Elevator Trim Fwd Low
1	MCS2295P25-47			Chain Elevator Trim Actuator
6	MCS2294-25			Chain Connecting Link
1	MC1260505-94 or 194			Elevator Trim Forward LH
1	MC1260505-93 or 193			Elevator Trim Forward RH
1	MC1260505-46 or 146			Elevator Trim Aft LH
1	MC1260505-91 or 191			Elevator Trim Aft RH
1	MC0510105-93 or 193 <sup>6</sup>			Flap Retract
1	MC0510105-94 or 194 <sup>6</sup>			Flap Retract
1	MC0510105-259 or 359			Flap Direct LH
1	MC0510105-92 or 192			Flap Direct RH
1	MC0510105-229 or 329			Rudder Forward LH
1	MC0510105-230 or 330			Rudder Forward RH
1	MC1260505-13 or 113			Rudder Aft LH
1	MC1260505-12 or 112			Rudder Aft RH

Available separately for aircraft with camera option

1	MC1260505-83 or 183			Rudder RH with Camera
1	MC1260505-84 or 184			Rudder LH with Camera
1	MC1260505-89 or 189			Elevator Up with Camera
1	MC1260505-88 or 188			Elevator Down with Camera
1	MC1260505-79 or 179			Elevator Trim RH with Camera
1	MC1260505-80 or 180			Elevator Trim LH with Camera

**207, 207A, T207, T207A, 1975-1980**  
 S/N 20700268 thru 20700646  
 Complete Cable Kit P/N CCTK207-06G (Galvanized)  
 Complete Cable Kit P/N CCTK207-06S (Stainless Steel)  
 Complete Pulley Kit P/N PULL-KT-60\* or -61\* Note 1

Qty	P/N	Galv	SS	Location
1	MC1260505-97 or 197			Park Brake
1	MC1260417-6 or 7			Park Brake Cable & Tube
1	MC1260078-8 or 108			Aileron Yoke RH
1	MC1260078-7 or 107			Aileron Yoke LH
1	MC1260078-5 or 105			Aileron Yoke Primary
2	MC1260505-55 or 155			Aileron Direct Inboard
2	MC1260505-58 or 158			Aileron Direct Outboard
1	MC1260505-60 or 160			Aileron Carry Thru LH
1	MC1260505-54 or 154			Aileron Carry Thru RH
2	MC1260505-307 or 407			Elevator
1	MCS2295A25-111			Chain Elevator Trim Fwd Up
1	MCS2295P25-185			Chain Elevator Trim Fwd Low
1	MCS2295P25-47			Chain Elevator Trim Actuator
1	MC1260505-94 or 194			Elevator Trim Forward LH
1	MC1260505-93 or 193			Elevator Trim Forward RH
1	MC1260505-46 or 146			Elevator Trim Aft LH
1	MC1260505-91 or 191			Elevator Trim Aft RH
1	MC0510105-93 or 193 <sup>6</sup>			Flap Retract
1	MC0510105-94 or 194 <sup>6</sup>			Flap Retract
1	MC0510105-259 or 359			Flap Direct LH
1	MC0510105-92 or 192			Flap Direct RH
1	MC0510105-229 or 329			Rudder Forward LH
1	MC0510105-230 or 330			Rudder Forward RH
1	MC1260505-13 or 113			Rudder Aft LH
1	MC1260505-12 or 112			Rudder Aft RH

Available separately for aircraft with camera option

1	MC1260505-83 or 183			Rudder RH with Camera
1	MC1260505-84 or 184			Rudder LH with Camera
2	MC1260505-310 or 410			Elevator with Camera
1	MC1260505-79 or 179			Elevator Trim RH with Camera
1	MC1260505-80 or 180			Elevator Trim LH with Camera

Note 1 S/N 20700268 thru 20700390 USE PULL-KT-60  
 S/N 20700391 thru 20700646 USE PULL-KT-61

**207A, T207A 1980-1981**  
 S/N 20700647 thru 20600672  
 Complete Cable Kit P/N CCTK207-07G (Galvanized)  
 Complete Cable Kit P/N CCTK207-07S (Stainless Steel)  
 Complete Pulley Kit P/N PULL-KT-61\*

Qty	P/N	Galv	SS	Location
1	MC1260505-317 or 417			Park Brake
1	MC1260417-6 or 7			Park Brake Cable & Tube
1	MC1260078-8 or 108			Aileron Yoke RH
1	MC1260078-7 or 107			Aileron Yoke LH
1	MC1260078-5 or 105			Aileron Yoke Primary
2	MC1260505-55 or 155			Aileron Direct Inboard
2	MC1260505-58 or 158			Aileron Direct Outboard
1	MC1260505-60 or 160			Aileron Carry Thru LH
1	MC1260505-54 or 154			Aileron Carry Thru RH
2	MC1260505-307 or 407			Elevator
1	MCS2295A25-111			Chain Elevator Trim Fwd Up
1	MCS2295P25-185			Chain Elevator Trim Fwd Low
1	MCS2295P25-47			Chain Elevator Trim Actuator

Kit continues in next column

Continued from previous column

Qty	P/N	Galv	SS	Location
6	MCS2294-25			Chain Connecting Link
1	MC1260505-94 or 194			Elevator Trim Forward LH
1	MC1260505-93 or 193			Elevator Trim Forward RH
1	MC1260505-46 or 146			Elevator Trim Aft LH
1	MC1260505-91 or 191			Elevator Trim Aft RH
1	MC0510105-93 or 193 <sup>6</sup>			Flap Retract
1	MC0510105-94 or 194 <sup>6</sup>			Flap Retract
1	MC0510105-259 or 359			Flap Direct LH
1	MC0510105-92 or 192			Flap Direct RH
1	MC0510105-229 or 329			Rudder Forward LH
1	MC0510105-230 or 330			Rudder Forward RH
1	MC1260505-13 or 113			Rudder Aft LH
1	MC1260505-12 or 112			Rudder Aft RH

Available separately for aircraft with camera option

1	MC1260505-83 or 183			Rudder RH with Camera
1	MC1260505-84 or 184			Rudder LH with Camera
2	MC1260505-310 or 410			Elevator with Camera
1	MC1260505-79 or 179			Elevator Trim RH with Camera
1	MC1260505-80 or 180			Elevator Trim LH with Camera

**207A, T207A 1981**  
 S/N 20700673 thru 20700729  
 Complete Cable Kit P/N CCTK207-08G (Galvanized)  
 Complete Cable Kit P/N CCTK207-08S (Stainless Steel)  
 Complete Pulley Kit P/N PULL-KT-61\*

Qty	P/N	Galv	SS	Location
1	MC1260505-317 or 417			Park Brake
1	MC1260417-6 or 7			Park Brake Cable & Tube
1	MC1260078-8 or 108			Aileron Yoke RH
1	MC1260078-7 or 107			Aileron Yoke LH
1	MC1260078-5 or 105			Aileron Yoke Primary
2	MC1260505-55 or 155			Aileron Direct Inboard
2	MC1260505-58 or 158			Aileron Direct Outboard
1	MC1260505-60 or 160			Aileron Carry Thru LH
1	MC1260505-54 or 154			Aileron Carry Thru RH
2	MC1260505-307 or 407			Elevator
1	MCS2295A25-111			Chain Elevator Trim Fwd Up
1	MCS2295P25-185			Chain Elevator Trim Fwd Low
1	MCS2295P25-47			Chain Elevator Trim Actuator
6	MCS2294-25			Chain Connecting Link
1	MC1260505-94 or 194			Elevator Trim Forward LH
1	MC1260505-93 or 193			Elevator Trim Forward RH
1	MC1260505-46 or 146			Elevator Trim Aft LH
1	MC1260505-91 or 191			Elevator Trim Aft RH
1	MC0510105-93 or 193 <sup>6</sup>			Flap Retract
1	MC0510105-94 or 194 <sup>6</sup>			Flap Retract
1	MC0510105-259 or 359			Flap Direct LH
1	MC0510105-92 or 192			Flap Direct RH
1	MC0510105-229 or 329			Rudder Forward LH
1	MC0510105-230 or 330			Rudder Forward RH
1	MC1260505-319 or 419			Rudder Aft LH
1	MC1260505-12 or 112			Rudder Aft RH

Available separately for aircraft with camera option

1	MC1260505-83 or 183			Rudder RH with Camera
1	MC1260505-84 or 184			Rudder LH with Camera
2	MC1260505-310 or 410			Elevator with Camera
1	MC1260505-79 or 179			Elevator Trim RH with Camera
1	MC1260505-80 or 180			Elevator Trim LH with Camera

**207A, T207A 1982-1984**  
 S/N 20700730 thru 20700788  
 Complete Cable Kit P/N CCTK207-09G (Galvanized)  
 Complete Cable Kit P/N CCTK207-09S (Stainless Steel)  
 Complete Pulley Kit P/N PULL-KT-61\*



# Flight Control System

## Flight Control Cables - Cessna

**Continued from previous page**

Qty	P/N	Galv	SS	Location
1	MC1260505-84 or 184			Rudder LH with Camera
2	MC1260505-310 or 410			Elevator with Camera
1	MC1260505-79 or 179			Elevator Trim RH with Camera
1	MC1260505-80 or 180			Elevator Trim LH with Camera
1	MC0510105-230 or 330			Rudder Forward RH
1	MC1260505-319 or 419			Rudder Aft LH
1	MC1260505-12 or 112			Rudder Aft RH

**208**  
See Caravan Section on page 247 for more details.  
S/N 20800001 thru 20899999  
Complete Cable Kit P/N CCTK208-01 (without autopilot) **10**  
Complete Cable Kit P/N CCTK208-02 (without autopilot) **11**  
Complete Cable Kit P/N CCTK208-03 (with autopilot) **12**  
Complete Cable Kit P/N CCTK208-04 (with autopilot) **13**  
Complete Cable Kit P/N CCTK208-05 (with autopilot) **14**

Qty	P/N	Location
1	MC2660001-100	Elevator
1	MC2660001-101	Elevator
1	MC2660001-102	Elevator
1	MC2660001-103	Elevator
1	MC2660001-104	Rudder
1	MC2660001-106	Rudder
1	MC2660001-107	Rudder
1	MC2660001-108	Rudder
1	MC2660001-109	Elevator Trim
1	MC2660001-110	Elevator Trim
1	MC2660001-112	Elevator Trim
2	MC2660001-114	Aileron
1	MC2660001-118	Aileron LH
1	MC2660001-119	Aileron RH
4	MC2660001-122	Aileron
1	MC2660001-123	Control Column Interconnect
1	MC2660001-124	Control Column Interconnect
1	MC2660001-125	Control Column Interconnect
1	MC2660001-126	Control Column Interconnect
1	MC2660001-155	Elevator Trim
1	MC2660001-156	Elevator Trim
2	MC2660001-157	Aileron
1	MC2660029-13 Note 1	Aileron Trim
1	MC2660029-15 Note 1	Aileron Trim
2	MC2660029-4	Aileron Trim
1	MC9864054-9	Flap Indicator
1	MCS2295-25-101	Chain Elevator Trim Note 2
1	MCS2295-25-107 Note 3	Chain Pitch Trim Servo Note 4
1	MCS2295-25-247	Chain Elevator Trim
1	MCS2295-25-35	Chain Aileron Trim
1	MCS2295-25-43 Note 1	Chain Aileron Trim
2	MCS2295-25-87	Chain Elevator Trim
24	MCS2294-25	Chain Connecting Link

Note 1: S/N 20800082 thru 20899999  
Note 2: When equipped with electric trim  
Note 3: S/N 20800500 thru 20899999  
Note 4: When equipped with pitch trim servo

**208B**  
See Caravan Section on page 247 for more details.  
S/N 208B0001 thru 208B9999  
Complete Cable Kit P/N CCTK208B-01 (without autopilot) **15**  
Complete Cable Kit P/N CCTK208B-02 (with autopilot) **16**  
Complete Cable Kit P/N CCTK208B-03 (with autopilot) **17**

Qty	P/N	Location
1	MC2660001-100	Elevator
1	MC2660001-102	Elevator
1	MC2660001-104 Note 1	Rudder
2	MC2660001-105	Flaps
1	MC2660001-107	Rudder
1	MC2660001-109	Elevator Trim
1	MC2660001-110	Elevator Trim
1	MC2660001-112	Elevator Trim
2	MC2660001-114	Aileron
4	MC2660001-122	Aileron
1	MC2660001-123	Control Column Interconnect
1	MC2660001-124	Control Column Interconnect
1	MC2660001-125	Control Column Interconnect
1	MC2660001-126	Control Column Interconnect
1	MC2660001-147	Elevator
1	MC2660001-148	Rudder
1	MC2660001-149	Elevator Trim
1	MC2660001-150	Elevator Trim
1	MC2660001-151	Aileron
1	MC2660001-152	Aileron
1	MC2660001-153	Elevator
1	MC2660001-154	Rudder
2	MC2660001-157	Aileron
2	MC2660029-11	Aileron Trim
1	MC2660029-13	Aileron Trim
1	MC2660029-15	Aileron Trim
1	MC9864054-7	Flap Indicator
1	MCS2295-25-101	Chain Elevator Trim Note 2
1	MCS2295-25-107 Note 3	Chain Pitch Trim Servo Note 4
1	MCS2295-25-247	Chain Elevator Trim
1	MCS2295-25-35	Chain Aileron Trim
1	MCS2295-25-43	Chain Aileron Trim
2	MCS2295-25-87	Chain Elevator Trim

Kit continues in next column

**Continued from previous column**

Qty	P/N	Galv	SS	Location
24	MCS2294-25			Chain Connecting Link
Note 1: S/N 208B0001 thru 208B2012, 208B2036 and 208B2048 thru 208B9999				
Note 2: When equipped with electric trim				
Note 3: S/N 208B2000 thru 208B9999				
Note 4: When equipped with pitch trim servo				
<b>210, 210A 1960-1961</b>				
S/N 57001 thru 21057840				
Complete Cable Kit P/N CCTK210-01G (Galvanized)				
Complete Cable Kit P/N CCTK210-01S (Stainless Steel)				
Complete Pulley Kit P/N PULL-KT-62*				

Qty	P/N	Galv	SS	Location
1	MC1260105-13 or 113			Park Brake
4	MC1260105-12			Aileron Control Tee
2	MC1260105-3 or 103			Aileron Direct
1	MC0510105-13 or 113			Aileron Carry Thru
1	MC1260105-5 or 105			Elevator Up
1	MC1260105-6 or 106			Elevator Down
1	MC1260105-12 or 112			Elevator Down Spring
1	MC1260105-4 or 104			Elevator Trim Forward LH
1	MC1260105-14 or 114			Elevator Trim Aft LH
1	MC1260105-15 or 115			Elevator Trim Forward RH
1	MC1260105-16 or 116			Elevator Trim Aft RH
1	MCS2295P25-321			Chain Elevator Trim Forward
1	MCS2295P25-113			Chain Elevator Trim Aft
4	MCS2294-25			Chain Connecting Link
2	MC1260105-10 or 110			Flap
2	MC1260105-11 or 111			Flap
1	MC1260105-8 or 108			Rudder RH Forward
1	MC1260105-9 or 109			Rudder Aft LH
1	MC1260105-17 or 117			Rudder Aft RH
1	MC1260105-7 or 107			Rudder LH Forward
4	MC0422280			Bellcrank Aileron Bushing

**210B 1962**  
S/N 21057841 thru 21058085  
Complete Cable Kit P/N CCTK210-02G (Galvanized)  
Complete Cable Kit P/N CCTK210-02S (Stainless Steel)  
Complete Pulley Kit P/N PULL-KT-63\*

Qty	P/N	Galv	SS	Location
1	MC1260505-16			Park Brake
1	MC1260417-1 or 2			Park Brake Cable & Tube
2	MC1260505-3 or 103			Aileron Direct
1	MC0510105-13 or 113			Aileron Carry Thru
1	MC1260105-9 or 109			Elevator Down
1	MC1260505-10 or 110			Elevator Up
1	MC1260505-2 or 102			Elevator Down Spring
1	MCS2295A25-111			Chain Elevator Trim Fwd Low
1	MCS2295P25-155			Chain Elevator Trim Fwd Up
1	MC1260505-5 or 105			Elevator Trim Forward RH
1	MC1260505-6 or 106			Elevator Trim Forward LH
1	MC1260505-7 or 107			Elevator Trim Aft RH
1	MC1260505-8 or 108			Elevator Trim Aft LH
1	MCS2295P25-113			Chain Elevator Trim Actuator
6	MCS2294-25			Chain Connecting Link
2	MC1260505-14 or 114			Flap
2	MC1260505-4 or 104			Flap
1	MC1260505-15 or 115			Rudder Forward LH
1	MC1260505-11 or 111			Rudder Forward RH
1	MC1260505-13 or 113			Rudder Aft LH
1	MC1260505-12 or 112			Rudder Aft RH
4	MC0422280			Bellcrank Aileron Bushing

**210C 1963**  
S/N 21058086 thru 21058220  
Complete Cable Kit P/N CCTK210-03G (Galvanized)  
Complete Cable Kit P/N CCTK210-03S (Stainless Steel)  
Complete Pulley Kit P/N PULL-KT-63\*

Qty	P/N	Galv	SS	Location
1	MC1260505-12			Park Brake
1	MC1260417-1 or 2			Park Brake Cable & Tube
2	MC1260505-3 or 103			Aileron Direct
1	MC0510105-13 or 113			Aileron Carry Thru
1	MC1260105-9 or 109			Elevator Down
1	MC1260505-10 or 110			Elevator Up
1	MC1260505-2 or 102			Elevator Down Spring
1	MCS2295A25-111			Chain Elevator Trim Fwd Low
1	MCS2295P25-155			Chain Elevator Trim Fwd Up
1	MC1260505-22 or 122			Elevator Trim Forward RH
1	MC1260505-6 or 106			Elevator Trim Forward LH
1	MC1260505-20 or 120			Elevator Trim Aft RH
1	MC1260505-8 or 108			Elevator Trim Aft LH
1	MCS2295P25-113			Chain Elevator Trim Actuator
2	MC1260505-14 or 114			Flap
2	MC1260505-4 or 104			Flap
1	MC1260505-15 or 115			Rudder Forward LH
1	MC1260505-11 or 111			Rudder Forward RH
1	MC1260505-13 or 113			Rudder Aft LH
1	MC1260505-12 or 112			Rudder Aft RH
6	MCS2294-25			Chain Connecting Link
4	MC0422280			Bellcrank Aileron Bushing

**210D,E,F, T210F 1964-1966**  
S/N 21058221 thru 21058818, T210-0001 thru T210-0197  
Complete Cable Kit P/N CCTK210-04G (Galvanized)  
Complete Cable Kit P/N CCTK210-04S (Stainless Steel)  
Complete Pulley Kit P/N PULL-KT-64\*

Qty	P/N	Galv	SS	Location
1	MC1260505-12			Park Brake
1	MC1260417-1 or 2			Park Brake Cable & Tube
2	MC1260505-25 or 125			Aileron Direct Inboard
2	MC1260505-26 or 126			Aileron Direct Outboard
1	MC1260505-23 or 123			Aileron Carry Thru LH
1	MC1260505-27 or 127			Aileron Carry Thru RH
1	MC1260505-32 or 132			Elevator Down
1	MC1260505-33 or 133			Elevator Up
1	MC1260505-31 or 131			Elevator Down Spring
1	MCS2295A25-111			Chain Elevator Trim Fwd Low
1	MCS2295P25-155			Chain Elevator Trim Fwd Up
1	MC1260505-22 or 122			Elevator Trim Forward RH
1	MC1260505-6 or 106			Elevator Trim Forward LH
1	MC1260505-20 or 120			Elevator Trim Aft RH
1	MC1260505-8 or 108			Elevator Trim Aft LH
1	MCS2295P25-113			Chain Elevator Trim Actuator
1	MC0510105-93 or 193			Flap Retract
1	MC0510105-94 or 194			Flap Retract
1	MC0510105-91 or 191			Flap Direct LH
1	MC0510105-92 or 192			Flap Direct RH
1	MC1260505-15 or 115			Rudder Forward LH
1	MC1260505-11 or 111			Rudder Forward RH
1	MC1260505-13 or 113			Rudder Aft LH
1	MC1260505-12 or 112			Rudder Aft RH
6	MCS2294-25			Chain Connecting Link

**210G, T210G, T1967**  
S/N 21058819 thru 21058829, T210-0198 thru T210-0240  
Complete Cable Kit P/N CCTK210-05G (Galvanized)  
Complete Cable Kit P/N CCTK210-05S (Stainless Steel)  
Complete Pulley Kit P/N PULL-KT-65\*

Qty	P/N	Galv	SS	Location
1	MC1260505-1 or 101			Park Brake
1	MC1260417-1 or 2			Park Brake Cable & Tube
1	MC1260078-3 or 103			Aileron Yoke RH
1	MC1260078-2 or 102			Aileron Yoke LH
1	MC20905-3			Aileron Yoke Carry Thru
2	MC1260078-4 or 104			Aileron Direct
2	MC1260505-40 or 140			Aileron Direct
1	MC1260505-38 or 138			Aileron Return LH
1	MC1260505-39 or 139			Aileron Return RH
1	MC1260505-32 or 132			Elevator Down
1	MC1260505-33 or 133			Elevator Up
1	MCS2295A25-111			Chain Elevator Trim Fwd Low
1	MCS2295P25-159			Chain Elevator Trim Fwd Up
1	MC1260505-22 or 122			Elevator Trim Forward RH
1	MC1260505-35 or 135			Elevator Trim Forward LH
1	MC1260505-45 or 145			Elevator Trim Aft RH
1	MC1260505-46 or 146			Elevator Trim Aft LH
1	MCS2295-25-43			Chain Elevator Trim Actuator
1	MC1260505-49 or 149			Flap Down LH Act to Trnbl
1	MC1260505-51 or 151			Flap Down RH Act to Trnbl
2	MC1260505-47 or 147			Flap Down LH/RH Bell/Trnbl
2	MC1260505-48 or 148			Flap Up LH/RH Bell/Trnbl
1	MC1260505-50 or 150			Flap Up LH Trnbl to Actuator
1	MC1260505-52 or 152			Flap Up RH Trnbl to Actuator
1	MC1260505-15 or 115			Rudder Forward LH
1	MC1260505-11 or 111			Rudder Forward RH
1	MC1260505-13 or 113			Rudder Aft LH
1	MC1260505-12 or 112			Rudder Aft RH
6	MCS2294-25			Chain Connecting Link

**210G, T210G, T1967**  
S/N 21058830 thru 21058936, T210-0241 thru T210-0307  
Complete Cable Kit P/N CCTK210-06G (Galvanized)  
Complete Cable Kit P/N CCTK210-06S (Stainless Steel)  
Complete Pulley Kit P/N PULL-KT-65\*

Qty	P/N	Galv	SS	Location
1	MC1260505-1 or 101			Park Brake
1	MC1260417-1 or 2			Park Brake Cable & Tube
1	MC1260078-8 or 108			Aileron Yoke RH
1	MC1260078-7 or 107			Aileron Yoke LH
1	MC1260078-5 or 105			Aileron Yoke Carry Thru
2	MC1260078-9 or 109			Aileron Direct Yoke
2	MC1260505-40 or 140			Aileron Direct Bellcrank
1	MC1260505-38 or 138			Aileron Return LH
1	MC1260505-39 or 139			Aileron Return RH
1	MC1260505-32 or 132			Elevator Down
1	MC1260505-33 or 133			Elevator Up

Kit continues on next page

\* See pages 122-124 for Pulley Kit Components  
**1** Partial model eligibility  
**2** Included in both galvanized and stainless kits.  
**3** Due to inconsistency in OEM parts these flap cables should be replaced at the same time.  
**4** Included in kits for electric trim aircraft only.  
**10** S/N 20800001 thru 20800081 without autopilot  
**11** S/N 20800082 thru 20899999 without autopilot  
**12** S/N 20800001 thru 20800081 with autopilot  
**13** S/N 20800082 thru 20800499 with autopilot  
**14** S/N 20800500 thru 20899999 with autopilot  
**15** All serials without autopilot  
**16** S/N 208B0001 thru 208B1999 with autopilot  
**17** S/N 208B2000 thru 208B9999 with autopilot





Continued from previous page

Qty	P/N	Galv	SS	Location
1	MCS2295A25-111			Chain Elevator Trim Fwd Up
1	MCS2295P25-159			Chain Elevator Trim Fwd Low
1	MC1260505-22 or 122			Elevator Trim Forward RH
1	MC1260505-35 or 135			Elevator Trim Forward LH
1	MC1260505-45 or 145			Elevator Trim Aft RH
1	MC1260505-46 or 146			Elevator Trim Aft LH
1	MCS2295-25-43			Chain Elevator Trim Actuator
1	MC1260505-49 or 149			Flap Down LH Act to Trnbkl
1	MC1260505-51 or 151			Flap Down RH Act to Trnbkl
2	MC1260505-47 or 147			Flap Down LH/RH Bell/Tnbkl
2	MC1260505-48 or 148			Flap Up LH/RH Bell/Tnbkl
1	MC1260505-50 or 150			Flap Up LH Trnbkl to Actuator
1	MC1260505-52 or 152			Flap Up RH Trnbkl to Actuator
1	MC1260505-15 or 115			Rudder Forward LH
1	MC1260505-11 or 111			Rudder Forward RH
1	MC1260505-13 or 113			Rudder Aft LH
1	MC1260505-12 or 112			Rudder Aft RH
6	MCS2294-25			Chain Connecting Link

**210H, T210H 1968**  
Serial 21058937 thru 21059030, T210-0308 thru T210-0378  
Complete Cable Kit P/N CCTK210-07G (Galvanized)  
Complete Cable Kit P/N CCTK210-07S (Stainless Steel)  
Complete Cable Kit P/N CCTK210-07GE (Galv. Elec. Trim)  
Complete Cable Kit P/N CCTK210-07SE (SS Electric Trim)  
Complete Pulley Kit P/N PULL-KT-66\*

Qty	P/N	Galv	SS	Location
1	MC1260505-1 or 101			Park Brake
1	MC1260417-1 or 2			Park Brake Cable & Tube
1	MC1260078-8 or 108			Aileron Yoke RH
1	MC1260078-7 or 107			Aileron Yoke LH
1	MC1260078-5 or 105			Aileron Yoke Carry Thru
2	MC1260078-9 or 109			Aileron Direct Yoke
2	MC1260505-40 or 140			Aileron Direct Bellcrank
1	MC1260505-38 or 138			Aileron Return LH
1	MC1260505-39 or 139			Aileron Return RH
1	MC1260505-32 or 132			Elevator Down
1	MC1260505-33 or 133			Elevator Up
1	MCS2295A25-111			Chain Elevator Trim Fwd Up
1	MCS2295P25-159			Chain Elevator Trim Fwd Low
1	MC1260505-22 or 122			Elevator Trim Forward RH
1	MC1260505-35 or 135			Elevator Trim Forward LH
1	MC1260505-45 or 145			Elevator Trim Aft RH
1	MC1260505-46 or 146			Elevator Trim Aft LH
1	MCS2295-25-43			Chain Elevator Trim Actuator
1	MC1260505-56 or 156			Elevator Aft RH
1	MC1260505-62 or 162			Electric Trim Forward RH
1	MC1260505-61 or 161			Electric Trim Forward LH
1	MC1260505-167			Electric Trim Cen. LH SS
1	MC1260505-49 or 149			Flap Down LH Act to Trnbkl
1	MC1260505-51 or 151			Flap Down RH Act to Trnbkl
2	MC1260505-47 or 147			Flap Down LH/RH Bell/Tnbkl
2	MC1260505-48 or 148			Flap Up Bellcrank to Trnbkl
1	MC1260505-50 or 150			Flap Up LH Trnbkl to Actuator
1	MC1260505-52 or 152			Flap Up RH Trnbkl to Act
1	MC1260505-15 or 115			Rudder Forward LH
1	MC1260505-11 or 111			Rudder Forward RH
1	MC1260505-13 or 113			Rudder Aft LH
1	MC1260505-12 or 112			Rudder Aft RH
6	MCS2294-25			Chain Connecting Link

**210H, T210H 1968**  
S/N 21059031 thru 21059061, T210-0379 thru T210-0392  
Complete Cable Kit P/N CCTK210-08G (Galvanized)  
Complete Cable Kit P/N CCTK210-08S (Stainless Steel)  
Complete Cable Kit P/N CCTK210-08GE (Galv. Elec. Trim)  
Complete Cable Kit P/N CCTK210-08SE (SS Electric Trim)  
Complete Pulley Kit P/N PULL-KT-67\*

Qty	P/N	Galv	SS	Location
1	MC1260505-1 or 101			Park Brake
1	MC1260417-1 or 2			Park Brake Cable & Tube
1	MC1260078-8 or 108			Aileron Yoke RH
1	MC1260078-7 or 107			Aileron Yoke LH
1	MC1260078-5 or 105			Aileron Yoke Carry Thru
2	MC1260078-9 or 109			Aileron Direct Yoke
2	MC1260505-40 or 140			Aileron Direct Bellcrank
1	MC1260505-38 or 138			Aileron Return LH
1	MC1260505-39 or 139			Aileron Return RH
1	MC1260505-32 or 132			Elevator Down
1	MC1260505-33 or 133			Elevator Up
1	MCS2295A25-111			Chain Elevator Trim Fwd Up
1	MCS2295P25-159			Chain Elevator Trim Fwd Low
1	MC1260505-22 or 122			Elevator Trim Forward RH
1	MC1260505-35 or 135			Elevator Trim Forward LH
1	MC1260505-45 or 145			Elevator Trim Aft RH
1	MC1260505-46 or 146			Elevator Trim Aft LH
1	MCS2295-25-43			Chain Elevator Trim Actuator
1	MC1260505-56 or 156			Elevator Aft RH
1	MC1260505-62 or 162			Electric Trim Forward RH
1	MC1260505-61 or 161			Electric Trim Forward LH
1	MC1260505-167			Electric Trim Center LH SS
1	MC1260505-73 or 173			Flap Down LH Trnbkl to Act
1	MC1260505-71 or 171			Flap Down RH Trnbkl to Act

Kit continues in next column

Continued from previous column

Qty	P/N	Galv	SS	Location
2	MC1260505-48 or 148			Flap Up Bellcrk to Trnbkl
2	MC1260505-47 or 147			Flap Down LH/RH Bellcrank to Trnbkl
1	MC1260505-70 or 170			Flap Up LH Trnbkl to Actuator
1	MC1260505-72 or 172			Flap Up RH Trnbkl to Act
1	MC1260505-15 or 115			Rudder Forward LH
1	MC1260505-11 or 111			Rudder Forward RH
1	MC1260505-13 or 113			Rudder Aft LH
1	MC1260505-12 or 112			Rudder Aft RH
6	MCS2294-25			Chain Connecting Link

**210J, T210J 1969**  
S/N 21059062 thru 21059100, T210-0393 thru T210-0407  
Complete Cable Kit P/N CCTK210-09G (Galvanized)  
Complete Cable Kit P/N CCTK210-09S (Stainless Steel)  
Complete Cable Kit P/N CCTK210-09GE (Galv. Elec. Trim)  
Complete Cable Kit P/N CCTK210-09SE (SS Electric Trim)  
Complete Pulley Kit P/N PULL-KT-68\*

Qty	P/N	Galv	SS	Location
1	MC1260505-1 or 101			Park Brake
1	MC1260417-1 or 2			Park Brake Cable & Tube
1	MC1260078-8 or 108			Aileron Yoke RH
1	MC1260078-7 or 107			Aileron Yoke LH
1	MC1260078-5 or 105			Aileron Yoke Carry Thru
2	MC1260208-1			Aileron/Rudder Int Lower
2	MC1260505-174			Aileron/Rudder Int Upper
1	MC1260505-187			Aileron/Rud Int Up with Tube
2	MC1260078-9 or 109			Aileron Direct Yoke
2	MC1260505-40 or 140			Aileron Direct Bellcrank
1	MC1260505-38 or 138			Aileron Return LH
1	MC1260505-39 or 139			Aileron Return RH
1	MC1260505-32 or 132			Elevator Down
1	MC1260505-33 or 133			Elevator Up
1	MCS2295A25-111			Chain Elevator Trim Fwd Up
1	MCS2295P25-159			Chain Elevator Trim Fwd Low
1	MC1260505-22 or 122			Elevator Trim Forward RH
1	MC1260505-35 or 135			Elevator Trim Forward LH
1	MC1260505-45 or 145			Elevator Trim Aft RH
1	MC1260505-46 or 146			Elevator Trim Aft LH
1	MCS2295-25-43			Chain Elevator Trim Actuator
1	MC1260505-56 or 156			Elevator Aft RH
1	MC1260505-62 or 162			Electric Trim Forward RH
1	MC1260505-61 or 161			Electric Trim Forward LH
1	MC1260505-167			Electric Trim Cen. LH SS
1	MC1260505-73 or 173			Flap Down LH Trnbkl to Act
1	MC1260505-71 or 171			Flap Down RH Trnbkl to Act
2	MC1260505-48 or 148			Flp Up Bellcrank to Trnbkl
2	MC1260505-47 or 147			Flap Down LH/RH Bellcrank to Turnbuckle
1	MC1260505-70 or 170			Flap Up LH Turnbuckle to Act
1	MC1260505-72 or 172			Flap Up RH Turnbuckle to Act
1	MC1260505-15 or 115			Rudder Forward LH
1	MC1260505-11 or 111			Rudder Forward RH
1	MC1260505-13 or 113			Rudder Aft LH
1	MC1260505-12 or 112			Rudder Aft RH
6	MCS2294-25			Chain Connecting Link

**210J, T210J 1969**  
S/N 21059101 thru 21059199, T210-0408 thru T210-0454  
Complete Cable Kit P/N CCTK210-10G (Galvanized)  
Complete Cable Kit P/N CCTK210-10S (Stainless Steel)  
Complete Cable Kit P/N CCTK210-10GE (Galv. Elec. Trim)  
Complete Cable Kit P/N CCTK210-10SE (SS Electric Trim)  
Complete Pulley Kit P/N PULL-KT-68\*

Qty	P/N	Galv	SS	Location
1	MC1260505-1 or 101			Park Brake
1	MC1260417-1 or 2			Park Brake Cable & Tube
1	MC1260078-8 or 108			Aileron Yoke RH
1	MC1260078-7 or 107			Aileron Yoke LH
1	MC1260078-5 or 105			Aileron Yoke Carry Thru
2	MC1260208-1			Aileron/Rudder Int Lower
2	MC1260505-174			Aileron/Rudder Int Upper
1	MC1260505-187			Ail/Rud Int Upper w/Tube
2	MC1260078-9 or 109			Aileron Direct Yoke
2	MC1260505-40 or 140			Aileron Direct Bellcrank
1	MC1260505-38 or 138			Aileron Return LH
1	MC1260505-39 or 139			Aileron Return RH
1	MC1260505-32 or 132			Elevator Down
1	MC1260505-33 or 133			Elevator Up
1	MCS2295A25-111			Chain Elevator Trim Fwd Up
1	MCS2295P25-159			Chain Elevator Trim Fwd Low
1	MC1260505-22 or 122			Elevator Trim Forward RH
1	MC1260505-35 or 135			Elevator Trim Forward LH
1	MC1260505-45 or 145			Elevator Trim Aft RH
1	MC1260505-46 or 146			Elevator Trim Aft LH
1	MCS2295-25-43			Chain Elevator Trim Actuator
1	MC1260505-56 or 156			Elevator Aft RH
1	MC1260505-62 or 162			Electric Trim Forward RH
1	MC1260505-61 or 161			Electric Trim Forward LH
1	MC1260204-1			Elevator Trim Cen. LH SS
1	MC1260505-73 or 173			Flap Down LH Trnbkl to Act
1	MC1260505-71 or 171			Flap Down RH Trnbkl to Act
2	MC1260505-48 or 148			Flap Up Bellcrk to Trnbkl

Kit continues in next column

Continued from previous column

Qty	P/N	Galv	SS	Location
2	MC1260505-47 or 147			Flap Down LH/RH Bellcrank to Turnbuckle
1	MC1260505-70 or 170			Flap Up LH Turnbuckle to Act
1	MC1260505-72 or 172			Flap Up RH Turnbuckle to Act
1	MC1260505-15 or 115			Rudder Forward LH
1	MC1260505-11 or 111			Rudder Forward RH
1	MC1260505-13 or 113			Rudder Aft LH
1	MC1260505-12 or 112			Rudder Aft RH
6	MCS2294-25			Chain Connecting Link

**210K, T210K 1970**  
S/N 21059200 thru 21059323  
Complete Cable Kit P/N CCTK210-11G (Galvanized)  
Complete Cable Kit P/N CCTK210-11S (Stainless Steel)  
Complete Pulley Kit P/N PULL-KT-69\*

Qty	P/N	Galv	SS	Location
1	MC1260505-1 or 101			Park Brake
1	MC1260417-1 or 2			Park Brake Cable & Tube
1	MC1260078-8 or 108			Aileron Yoke RH
1	MC1260078-7 or 107			Aileron Yoke LH
1	MC1260078-5 or 105			Aileron Yoke Carry Thru
2	MC1260208-1			Aileron/Rudder Int Lower
1	MC1260505-174			Aileron/Rudder Int Upper
1	MC1260505-187			Ail/Rud Int Upper w/Tube
2	MC1260078-9 or 109			Aileron Direct Yoke
2	MC1260505-40 or 140			Aileron Direct Bellcrank
1	MC1260505-38 or 138			Aileron Return LH
1	MC1260505-39 or 139			Aileron Return RH
1	MC1260475-7 or 107			Elevator Up
1	MC1260475-8 or 108			Elevator Down
1	MC1260505-96 or 196			Elevator Down Spring
1	MCS2295A25-111			Chain Elevator Trim Fwd Up
1	MCS2295P25-159			Chain Elevator Trim Fwd Low
1	MC1260475-1 or 101			Elevator Trim Forward LH
1	MC1260475-2 or 102			Elevator Trim Forward RH
1	MC1260475-9 or 109			Elevator Trim Aft LH
1	MC1260475-10 or 110			Elevator Trim Aft RH
1	MC1260660-3			Elevator Trim Electric Drive
1	MC1260505-73 or 173			Flap Down LH Trnbkl to Act
1	MC1260505-71 or 171			Flap Down RH Trnbkl to Act
2	MC1260505-48 or 148			Flap Up Bellcrank to Trnbkl
2	MC1260505-47 or 147			Flap Down Bellcrk to Trnbkl
1	MC1260505-70 or 170			Flap Up LH Turnbuckle to Act
1	MC1260505-72 or 172			Flap Up RH Turnbuckle to Act
1	MC1260475-8 or 108			Rudder Forward LH
1	MC1260505-96 or 196			Rudder Forward RH
1	MCS2295A25-111			Chain Elevator Trim Fwd Up
1	MCS2295P25-159			Chain Elevator Trim Fwd Low
1	MC1260475-1 or 101			Elevator Trim Forward LH
1	MC1260475-2 or 102			Elevator Trim Forward RH
1	MC1260475-9 or 109			Elevator Trim Aft LH
1	MC1260475-10 or 110			Elevator Trim Aft RH
1	MC1260660-3			Elevator Trim Elec Drive
1	MC1260505-73 or 173			Flap Down LH Trnbkl to Act
1	MC1260505-71 or 171			Flap Down RH Trnbkl to Act
2	MC1260505-48 or 148			Flap Up Bellcrk to Trnbkl
2	MC1260505-47 or 147			Flap Down Bellcrk to Trnbkl
1	MC1260505-70 or 170			Flap Up LH Turnbuckle to Act
1	MC1260505-72 or 172			Flap Up RH Turnbuckle to Act
6	MCS2294-25			Chain Connecting Link

**210K, T210K 1970-1971**  
S/N 21059324 thru 21059465  
Complete Cable Kit P/N CCTK210-12G (Galvanized)  
Complete Cable Kit P/N CCTK210-12S (Stainless Steel)  
Complete Pulley Kit P/N PULL-KT-69\*

Qty	P/N	Galv	SS	Location
1	MC1260505-1 or 101			Park Brake
1	MC1260417-1 or 2			Park Brake Cable & Tube
1	MC1260078-8 or 108			Aileron Yoke RH
1	MC1260078-7 or 107			Aileron Yoke LH
1	MC1260078-5 or 105			Aileron Yoke Carry Thru
2	MC1260208-1			Aileron/Rudder Int Lower





Continued from previous page

Qty	P/N	Galv	SS	Location
1	MC1260505-326 or 426			Elevator Trim Aft RH
1	MC1260505-73 or 173			Flap Down LH Trmbkl to Act
2	MC1260505-48 or 148			Flap Up Bellcrank to Trnbkl
2	MC1260505-47 or 147			Flap Down LH/RH Bellcrank to Turnbuckle
1	MC1260505-71 or 171			Flap Down RH Trmbkl to Act
1	MC1260505-70 or 170			Flap Up LH Turnbuckle to Act
1	MC1260505-72 or 172			Flap Up RH Turnbuckle to Act
1	MC1260475-5 or 105			Rudder Forward LH
1	MC1260475-6 or 106			Rudder Forward RH
1	MC1260505-329 or 429			Rudder Aft LH
1	MC1260505-330 or 430			Rudder Aft RH
6	MCS2294-25			Chain Connecting Link

\* See pages 122-124 for Pulley Kit Components  
**1** Partial model eligibility  
**2** Included in both galvanized and stainless kits.

### Stabilator Adjust Cables for Piper Aircraft

- Time tested 'long splice' method for strength and reliability
- Available in galvanized or stainless
- Custom lengths available for your antique projects



Model	S/N	P/N	Cable Comp.
J-3, PA-11	All	MC41671-2	Galvanized
PA-12	All	MC41671-5	Galvanized
PA-12	All	MC41671-6	Stainless
J-3, PA-11	All	MC41671-8	Stainless
PA-14	All	MC41671-9	Galvanized
PA-16, PA-20	All	MC41671-11	Galvanized
PA-14	All	MC41671-12	Galvanized
PA-18, PA-18A	1 thru 548	MC41671-13	Galvanized
PA-16	All	MC41671-14	Stainless
PA-18, PA-18A	All with Floats	MC41671-15	Stainless
PA-20, PA-22	All	MC41671-16	Galvanized
PA-18, PA-18A	549 and On	MC41671-17	Galvanized
PA-22	354 and On	MC41671-18	Stainless
PA-18, PA-18A	All with Floats	MC41671-19	Stainless



### Cables for AG-CAT Aircraft

Aileron Cables			
Model	Location	Part Number	Per A/C
G-164	Upper Sector	MCA1860-101	2
G-164	Lower Sector	MCA1860-101	2
G164A	Upper Sector	MCA1860-401	2
G164A	Lower Sector	MCA1860-101	2
G164B	Upper Sector	MCA2860-7	2
G164B	Lower Sector	MCA2860-5	2
Rudder Cables			
G164, G164A	Left Hand	MCA1860-35	1
G164, G164A	Right Hand	MCA1860-36	1
G164B	Left & Right	MCA3860-3	2



Subassemblies consisting of a long and short cable are available. Call for details.

### How to Determine Flight Cable Composition

Using a magnet to determine if a cable is galvanized steel or stainless steel alloy can be unreliable as stainless steel can display magnetic properties which can make alloy discrimination difficult. The unreliability comes from variation in the amount of magnetic permeability found in the stainless steel cable and from strength differences in the magnets used. Stainless steel cables become magnetic in the process of cold working stainless steel wires into cable. The amount of magnetic permeability varies with the amount of cold working the cable was subject to. It is also possible cables in-service will become more magnetic over time as they work-harden through use.



A better test is to use an ohm meter to measure the resistance in a length of cable. Stainless steel has more electrical resistance than zinc or tin coated high carbon steel, which allows us to identify cable composition by the amount of resistance in a length of cable. This test is applicable to the most common aircraft cable diameters: 1/16 through 5/32 with 7x7 or 7x19 construction. To ensure accuracy in cable resistance measurements, use the following procedure:

- You will need access to at least 3 feet of cable
- The ohm meter and leads must be in good condition
- Electrical isolation of the cable from the aircraft is required for an accurate resistance measurement. The cable should be removed from the aircraft or at least one end of the cable disconnected from the aircraft. Ensure the cable is not touching anything conductive between the freed end and the area of the measurement
- For non-auto ranging multimeters, set the resistance range to the lowest scale (typically 1x) and zero the meter
- Measure the resistance of the cable across a span of at least 3 feet. Assure that the cable is clean and you are getting good contact between the cable and the ohm meter leads
- Do not allow your fingers to touch the metallic probes of the ohm meter leads when measuring
- Galvanized cable and tin coated cable will register less than 1 ohm resistance while stainless steel will indicate more than 1 ohm
- If possible, check your meter on a length of cable where the alloy is known

If the cable is to be returned to service, reinstall and rig the cable as per the aircraft manufacturer's service manual. Install all required safety devices.

### Adjustable Elevator Neutral Rigging Tool for Cessna Aircraft

Save time, you'll always have the correct tool!  
**P/N TOOL126**

Proper elevator rigging is necessary for full range of motion and maneuverability of the airplane. Many Cessna maintenance manuals require the fabrication of a tool to hold the yoke in the neutral position while the mechanic rigs the elevator control system. These tools utilize the holes for the control gust lock. At least 17 different sizes of rigging tools are required to cover the various Cessna aircraft. Now there is one tool to replace them all.

The McFarlane Elevator Neutral Rigging Tool is adjustable from 0.4" to 2.5" and universal in design, consisting of six different pin sizes to fit your application. This tool may also be used to properly rig other makes of aircraft with similar elevator neutral rigging requirements.

#### Features and Benefits

- Replaces 17 costly tools
- Quick setup and adjustment
- Simple to use instructions
- Includes compact storage box
- Replacement parts available separately
- Stainless steel components



#### Note:

Refer to your Cessna maintenance manual to determine if your model requires the use of the elevator neutral rigging tool and follow its guidelines for proper pin selection and adjustment guidelines.



**Fits most Cessna**  
**150 thru 425**  
**aircraft!**

Elevator Neutral Rigging Tool Replacement Parts	
Part Number	Description
6409	.050"/1.3mm Hex Wrench
6870	Square Nut
6868-4	Pin, .188, Short
6868-3	Pin, .188, Long
6868-1	Pin, .209, Short
6868-2	Pin, .209, Long
6869-1	Pin, .250, Short
6869-2	Pin, .250, Long



**FAA-PMA Approved**

**PA28-140**  
S/N 28-20002 thru 28-20656  
Complete Kit P/N PKCT140-01  
Stabilator Kit P/N PKCT-STAB-01 **1**

Qty	Part Number	Location
1	MC62701-016	Stabilator Trim Indicator Aft
1	MC62701-032	Stabilator Trim
1	MC62701-010 <b>1</b>	Stabilator Forward LH
1	MC62701-011 <b>1</b>	Stabilator Forward RH
1	MC62701-012 <b>1</b>	Stabilator Aft Bottom
1	MC62701-013 <b>1</b>	Stabilator Aft Top
2	MC62701-006	Rudder Forward LH and RH
2	MC62701-008	Rudder Aft LH and RH
2	MC62701-002	Aileron Forward LH and RH
2	MC62701-003	Aileron Wing LH and RH
1	MC62701-004	Aileron Balance LH
1	MC62701-005	Aileron Balance RH
1	MC62701-014	Flap

**PA28-140**  
S/N 28-20002 thru 28-20656  
with Kit #756-896 or Kit #756-930 Installed,  
28-20657 thru 28-26956, 28-7125001 thru 28-7225612 with  
Kit #756-896 or Kit #756-930 Installed  
Complete Kit P/N PKCT140-02 (Manual Trim)  
Complete Kit P/N PKCT140-05 (Electric Trim)  
Stabilator Kit P/N PKCT-STAB-01 **1**

Qty	Part Number	Location
1	MC62701-016	Stabilator Trim Indicator Aft
1	MC62701-045 <b>2</b>	Stabilator Trim Forward (Manual)
1	MC62701-047	Stabilator Trim Aft
1	MC62701-044 <b>3</b>	Stabilator Trim Forward (Electric)
1	MC62701-010 <b>1</b>	Stabilator Forward LH
1	MC62701-011 <b>1</b>	Stabilator Forward RH
1	MC62701-012 <b>1</b>	Stabilator Aft Bottom
1	MC62701-013 <b>1</b>	Stabilator Aft Top
2	MC62701-006	Rudder Forward LH and RH
2	MC62701-008	Rudder Aft LH and RH
2	MC62701-002	Aileron Forward LH and RH
2	MC62701-003	Aileron Wing LH and RH
1	MC62701-004	Aileron Balance LH
1	MC62701-005	Aileron Balance RH
1	MC62701-014	Flap

**PA28-140**  
S/N 28-7325001 thru 28-7625234,  
28-7725001 thru 28-7725290  
Complete Kit P/N PKCT140-03 (Manual Trim)  
Complete Kit P/N PKCT140-04 (Electric Trim)  
Stabilator Kit P/N PKCT-STAB-01 **1**

Qty	Part Number	Location
2	MC62701-002	Aileron Forward LH and RH
2	MC62701-003	Aileron Wing LH and RH
1	MC62701-004	Aileron Balance LH
1	MC62701-005	Aileron Balance RH
2	MC62701-006	Rudder Forward LH and RH
2	MC62701-008	Rudder Aft LH and RH
1	MC62701-010 <b>1</b>	Stabilator Forward LH
1	MC62701-011 <b>1</b>	Stabilator Forward RH
1	MC62701-012 <b>1</b>	Stabilator Aft Bottom
1	MC62701-013 <b>1</b>	Stabilator Aft Top
1	MC62701-047	Stabilator Trim Aft
1	MC62701-016	Stabilator Trim Indicator Aft
2	MC62701-056 <b>4</b>	Stab Trim Fwd LH and RH (Manual)
1	MC62701-057 <b>3</b>	Stab Trim Fwd LH (Electric)
1	MC62701-014	Flap

**PA28-150**  
S/N 28-1 thru 28-1410  
Complete Kit P/N PKCT150-01  
Stabilator Kit P/N PKCT-STAB-01 **1**

Qty	Part Number	Location
2	MC62701-002	Aileron Forward LH and RH
2	MC62701-003	Aileron Wing LH and RH
1	MC62701-004	Aileron Balance LH
1	MC62701-005	Aileron Balance RH
2	MC62701-006	Rudder Forward LH and RH
2	MC62701-008	Rudder Aft LH and RH
1	MC62701-010 <b>1</b>	Stabilator Forward LH
1	MC62701-011 <b>1</b>	Stabilator Forward RH
1	MC62701-012 <b>1</b>	Stabilator Aft Bottom
1	MC62701-013 <b>1</b>	Stabilator Aft Top
1	MC62701-047	Stabilator Trim Aft
1	MC62701-016	Stabilator Trim Indicator Aft
1	MC62701-015	Stabilator Trim Forward
1	MC62701-014	Flap

**PA28-150**  
S/N 28-1 thru 28-2171  
With Kit # 756-896 or Kit #756-930 Installed  
Complete Kit P/N PKCT150-02  
Stabilator Kit P/N PKCT-STAB-01 **1**

Qty	Part Number	Location
2	MC62701-002	Aileron Forward LH and RH
2	MC62701-003	Aileron Wing LH and RH
1	MC62701-004	Aileron Balance LH
1	MC62701-005	Aileron Balance RH
2	MC62701-006	Rudder Forward LH and RH
2	MC62701-008	Rudder Aft LH and RH

**Continued from previous column**

Qty	Part Number	Location
1	MC62701-010 <b>1</b>	Stabilator Forward LH
1	MC62701-011 <b>1</b>	Stabilator Forward RH
1	MC62701-012 <b>1</b>	Stabilator Aft Bottom
1	MC62701-013 <b>1</b>	Stabilator Aft Top
1	MC62701-016	Stabilator Trim Indicator Aft
1	MC62701-045	Stabilator Trim Forward
1	MC62701-047	Stabilator Trim Aft
1	MC62701-014	Flap

**PA28-150**  
S/N 28-1411 thru 28-2171  
Complete Kit P/N PKCT150-03  
Stabilator Kit P/N PKCT-STAB-01 **1**

Qty	Part Number	Location
2	MC62701-002	Aileron Forward LH and RH
2	MC62701-003	Aileron Wing LH and RH
1	MC62701-004	Aileron Balance LH
1	MC62701-005	Aileron Balance RH
2	MC62701-006	Rudder Forward LH and RH
2	MC62701-008	Rudder Aft LH and RH
1	MC62701-010 <b>1</b>	Stabilator Forward LH
1	MC62701-011 <b>1</b>	Stabilator Forward RH
1	MC62701-012 <b>1</b>	Stabilator Aft Bottom
1	MC62701-013 <b>1</b>	Stabilator Aft Top
1	MC62701-014	Flap
1	MC62701-016	Stabilator Trim Indicator Aft
1	MC62701-032	Stabilator Trim

**PA28-150**  
S/N 28-2172 thru 28-4377  
Complete Kit P/N PKCT150-04 (Manual Trim)  
Complete Kit P/N PKCT150-05 (Electric Trim)  
Stabilator Kit P/N PKCT-STAB-01 **1**

Qty	Part Number	Location
2	MC62701-002	Aileron Forward LH and RH
2	MC62701-003	Aileron Wing LH and RH
1	MC62701-004	Aileron Balance LH
1	MC62701-005	Aileron Balance RH
2	MC62701-006	Rudder Forward LH and RH
2	MC62701-008	Rudder Aft LH and RH
1	MC62701-010 <b>1</b>	Stabilator Forward LH
1	MC62701-011 <b>1</b>	Stabilator Forward RH
1	MC62701-012 <b>1</b>	Stabilator Aft Bottom
1	MC62701-013 <b>1</b>	Stabilator Aft Top
1	MC62701-016	Stabilator Trim Indicator Aft
1	MC62701-045 <b>2</b>	Stab Trim Forward (Manual)
1	MC62701-047	Stabilator Trim Aft
1	MC62701-044 <b>3</b>	Stab Trim Forward (Electric)
1	MC62701-014	Flap

**PA28-151**  
S/N 28-7415001 thru 28-7715314  
Complete Kit P/N PKCT151-01 (Manual Trim)  
Complete Kit P/N PKCT151-02 (Electric Trim)  
Stabilator Kit P/N PKCT-STAB-03 **1**

Qty	Part Number	Location
2	MC62701-099	Aileron Forward LH and RH
2	MC62701-122	Aileron Wing LH and RH
1	MC62701-123	Aileron Balance LH
1	MC62701-124	Aileron Balance RH
2	MC62701-100	Rudder Forward LH and RH
2	MC62701-008	Rudder Aft LH and RH
1	MC62701-113 <b>1</b>	Stabilator Forward LH
1	MC62701-114 <b>1</b>	Stabilator Forward RH
1	MC62701-012 <b>1</b>	Stabilator Aft Bottom
1	MC62701-013 <b>1</b>	Stabilator Aft Top
1	MC62701-101	Flap
1	MC62701-047	Stabilator Trim Aft
2	MC62701-104 <b>4</b>	Stab Trim Fwd LH and RH (Manual)
1	MC62701-111 <b>3</b>	Stab Trim Forward LH (Electric)

**PA28-160**  
S/N 28-1 thru 28-1410  
Complete Kit P/N PKCT160-01  
Stabilator Kit P/N PKCT-STAB-01 **1**

Qty	Part Number	Location
2	MC62701-002	Aileron Forward LH and RH
2	MC62701-003	Aileron Wing LH and RH
1	MC62701-004	Aileron Balance LH
1	MC62701-005	Aileron Balance RH
2	MC62701-006	Rudder Forward LH and RH
2	MC62701-008	Rudder Aft LH and RH
1	MC62701-010 <b>1</b>	Stabilator Forward LH
1	MC62701-011 <b>1</b>	Stabilator Forward RH
1	MC62701-012 <b>1</b>	Stabilator Aft Bottom
1	MC62701-013 <b>1</b>	Stabilator Aft Top
1	MC62701-016	Stabilator Trim Indicator Aft
1	MC62701-015	Stabilator Trim
1	MC62701-014	Flap

**PA28-160**  
S/N 28-1 thru 28-2171  
With Kit # 756-896 or Kit #756-930 Installed  
Complete Kit P/N PKCT160-02  
Stabilator Kit P/N PKCT-STAB-01 **1**

Qty	Part Number	Location
2	MC62701-002	Aileron Forward LH and RH
2	MC62701-003	Aileron Wing LH and RH
1	MC62701-004	Aileron Balance LH
1	MC62701-005	Aileron Balance RH
2	MC62701-006	Rudder Forward LH and RH
2	MC62701-008	Rudder Aft LH and RH
1	MC62701-010 <b>1</b>	Stabilator Forward LH
1	MC62701-011 <b>1</b>	Stabilator Forward RH
1	MC62701-012 <b>1</b>	Stabilator Aft Bottom
1	MC62701-013 <b>1</b>	Stabilator Aft Top
1	MC62701-016	Stabilator Trim Indicator Aft
1	MC62701-045	Stabilator Trim Forward
1	MC62701-047	Stabilator Trim Aft
1	MC62701-014	Flap

**PA28-160**  
S/N 28-1411 thru 28-2171  
Complete Kit P/N PKCT160-03  
Stabilator Kit P/N PKCT-STAB-01 **1**

Qty	Part Number	Location
2	MC62701-002	Aileron Forward LH and RH
2	MC62701-003	Aileron Wing LH and RH
1	MC62701-004	Aileron Balance LH
1	MC62701-005	Aileron Balance RH
2	MC62701-006	Rudder Forward LH and RH
2	MC62701-008	Rudder Aft LH and RH
1	MC62701-010 <b>1</b>	Stabilator Forward LH
1	MC62701-011 <b>1</b>	Stabilator Forward RH
1	MC62701-012 <b>1</b>	Stabilator Aft Bottom
1	MC62701-013 <b>1</b>	Stabilator Aft Top
1	MC62701-014	Flap
1	MC62701-016	Stabilator Trim Indicator Aft
1	MC62701-032	Stabilator Trim

**PA28-160**  
S/N 28-2172 thru 28-4377  
Complete Kit P/N PKCT160-04 (Manual Trim)  
Complete Kit P/N PKCT160-05 (Electric Trim)  
Stabilator Kit P/N PKCT-STAB-01 **1**

Qty	Part Number	Location
2	MC62701-002	Aileron Forward LH and RH
2	MC62701-003	Aileron Wing LH and RH
1	MC62701-004	Aileron Balance LH
1	MC62701-005	Aileron Balance RH
2	MC62701-006	Rudder Forward LH and RH
2	MC62701-008	Rudder Aft LH and RH
1	MC62701-010 <b>1</b>	Stabilator Forward LH
1	MC62701-011 <b>1</b>	Stabilator Forward RH
1	MC62701-012 <b>1</b>	Stabilator Aft Bottom
1	MC62701-013 <b>1</b>	Stabilator Aft Top
1	MC62701-014	Flap
1	MC62701-016	Stabilator Trim Indicator Aft
1	MC62701-045 <b>2</b>	Stab Trim Forward (Manual)
1	MC62701-047	Stabilator Trim Aft
1	MC62701-044 <b>3</b>	Stab Trim Forward (Electric)
1	MC62701-014	Flap

**PA28-161**  
S/N 28-7716002 thru 28-8616057,  
2816001 thru 2816065, 2816067 thru 2816119,  
2841001 thru 2841365, 2842001 thru 2842999  
Complete Kit P/N PKCT161-01 (Manual Trim)  
Complete Kit P/N PKCT161-02 (Electric Trim)  
Stabilator Kit P/N PKCT-STAB-03 **1**

Qty	Part Number	Location
2	MC62701-099	Aileron Forward LH and RH
2	MC62701-122	Aileron Wing LH and RH
1	MC62701-123	Aileron Balance LH
1	MC62701-124	Aileron Balance RH
2	MC62701-100	Rudder Forward LH and RH
2	MC62701-008	Rudder Aft LH and RH
1	MC62701-113 <b>1</b>	Stabilator Forward LH
1	MC62701-114 <b>1</b>	Stabilator Forward RH
1	MC62701-012 <b>1</b>	Stabilator Aft Bottom
1	MC62701-013 <b>1</b>	Stabilator Aft Top
1	MC62701-101	Flap
1	MC62701-047	Stabilator Trim Aft
2	MC62701-104 <b>4</b>	Stab Trim Fwd LH and RH (Manual)
1	MC62701-111 <b>3</b>	Stabilator Trim Forward LH (Electric)

**1** Stabilator kits to assist with Piper AD2013-02-13 include cables designated with **1** plus 2 each MS21251-B5S Barrels and 10 each MS21256-1 Locking Clips.  
**2** Included in kits for manual trim aircraft only.  
**3** Included in kits for electric trim aircraft only.  
**4** Kits for electric trim aircraft include only one of this part number.

Flight Control System

# Flight Control System Flight Control Cables - Piper

**PA28-180**  
S/N 28-725 thru 28-1410  
Complete Kit P/N PKCT180-01  
Stabilator Kit P/N PKCT-STAB-01 **1**

Qty	Part Number	Location
2	MC62701-002	Aileron Forward LH and RH
2	MC62701-003	Aileron Wing LH and RH
1	MC62701-004	Aileron Balance LH
1	MC62701-005	Aileron Balance RH
2	MC62701-006	Rudder Forward LH and RH
2	MC62701-008	Rudder Aft LH and RH
1	MC62701-010 <b>1</b>	Stabilator Forward LH
1	MC62701-011 <b>1</b>	Stabilator Forward RH
1	MC62701-012 <b>1</b>	Stabilator Aft Bottom
1	MC62701-013 <b>1</b>	Stabilator Aft Top
1	MC62701-016	Stabilator Trim Indicator Aft
1	MC62701-015	Stabilator Trim
1	MC62701-014	Flap

**PA28-180**  
S/N 28-725 thru 28-2171  
With Kit # 756-896 or Kit #756-930 Installed  
Complete Kit P/N PKCT180-02  
Stabilator Kit P/N PKCT-STAB-01 **1**

Qty	Part Number	Location
2	MC62701-002	Aileron Forward LH and RH
2	MC62701-003	Aileron Wing LH and RH
1	MC62701-004	Aileron Balance LH
1	MC62701-005	Aileron Balance RH
2	MC62701-006	Rudder Forward LH and RH
2	MC62701-008	Rudder Aft LH and RH
1	MC62701-010 <b>1</b>	Stabilator Forward LH
1	MC62701-011 <b>1</b>	Stabilator Forward RH
1	MC62701-012 <b>1</b>	Stabilator Aft Bottom
1	MC62701-013 <b>1</b>	Stabilator Aft Top
1	MC62701-016	Stabilator Trim Indicator Aft
1	MC62701-045	Stabilator Trim Forward
1	MC62701-047	Stabilator Trim Aft
1	MC62701-014	Flap

**PA28-180**  
S/N 28-1411 thru 28-2171  
Complete Kit P/N PKCT180-03  
Stabilator Kit P/N PKCT-STAB-01 **1**

Qty	Part Number	Location
2	MC62701-002	Aileron Forward LH and RH
2	MC62701-003	Aileron Wing LH and RH
1	MC62701-004	Aileron Balance LH
1	MC62701-005	Aileron Balance RH
2	MC62701-006	Rudder Forward LH and RH
2	MC62701-008	Rudder Aft LH and RH
1	MC62701-010 <b>1</b>	Stabilator Forward LH
1	MC62701-011 <b>1</b>	Stabilator Forward RH
1	MC62701-012 <b>1</b>	Stabilator Aft Bottom
1	MC62701-013 <b>1</b>	Stabilator Aft Top
1	MC62701-014	Flap
1	MC62701-016	Stabilator Trim Indicator Aft
1	MC62701-032	Stabilator Trim

**PA28-180**  
S/N 28-2172 thru 28-4377  
Complete Kit P/N PKCT180-04 (Manual Trim)  
Complete Kit P/N PKCT180-09 (Electric Trim)  
Stabilator Kit P/N PKCT-STAB-01 **1**

Qty	Part Number	Location
2	MC62701-002	Aileron Forward LH and RH
2	MC62701-003	Aileron Wing LH and RH
1	MC62701-004	Aileron Balance LH
1	MC62701-005	Aileron Balance RH
2	MC62701-006	Rudder Forward LH and RH
2	MC62701-008	Rudder Aft LH and RH
1	MC62701-010 <b>1</b>	Stabilator Forward LH
1	MC62701-011 <b>1</b>	Stabilator Forward RH
1	MC62701-012 <b>1</b>	Stabilator Aft Bottom
1	MC62701-013 <b>1</b>	Stabilator Aft Top
1	MC62701-016	Stabilator Indicator Aft
1	MC62701-045 <b>2</b>	Stabilator Trim Forward (Manual)
1	MC62701-047	Stabilator Trim Aft
1	MC62701-044 <b>3</b>	Stabilator Trim Forward (Electric)
1	MC62701-014	Flap

**PA28-180**  
S/N 28-4378 thru 28-5869,  
28-7105001 thru 28-7205328  
Complete Kit P/N PKCT180-05 (Manual Trim)  
Complete Kit P/N PKCT180-06 (Electric Trim)  
Stabilator Kit P/N PKCT-STAB-01 **1**

Qty	Part Number	Location
2	MC62701-002	Aileron Forward LH and RH
2	MC62701-003	Aileron Wing LH and RH
1	MC62701-004	Aileron Balance LH
1	MC62701-005	Aileron Balance RH
2	MC62701-006	Rudder Forward LH and RH
2	MC62701-008	Rudder Aft LH and RH
1	MC62701-010 <b>1</b>	Stabilator Forward LH
1	MC62701-011 <b>1</b>	Stabilator Forward RH
1	MC62701-012 <b>1</b>	Stabilator Aft Bottom

Kit continues in next column

Continued from previous column

Qty	Part Number	Location
1	MC62701-013 <b>1</b>	Stabilator Aft Top
1	MC62701-047	Stabilator Trim Aft
2	MC62701-056 <b>4</b>	Stab Trim Fwd LH and RH (Manual)
1	MC62701-057 <b>3</b>	Stabilator Trim Forward LH (Electric)
1	MC62701-014	Flap

**PA28-180**  
S/N 28-7305001 thru 28-7505261  
Complete Kit P/N PKCT180-07 (Manual Trim)  
Complete Kit P/N PKCT180-08 (Electric Trim)  
Stabilator Kit P/N PKCT-STAB-03 **1**

Qty	Part Number	Location
2	MC62701-099	Aileron Forward LH and RH
2	MC62701-003	Aileron Wing LH and RH
1	MC62701-004	Aileron Balance LH
1	MC62701-005	Aileron Balance RH
2	MC62701-100	Rudder Forward LH and RH
2	MC62701-008	Rudder Aft LH and RH
1	MC62701-113 <b>1</b>	Stabilator Forward LH
1	MC62701-114 <b>1</b>	Stabilator Forward RH
1	MC62701-012 <b>1</b>	Stabilator Aft Bottom
1	MC62701-013 <b>1</b>	Stabilator Aft Top
1	MC62701-047	Stabilator Trim Aft
2	MC62701-104 <b>4</b>	Stab Trim Fwd LH and RH (Manual)
1	MC62701-111 <b>3</b>	Stabilator Trim Forward LH (Electric)
1	MC62701-101	Flap

**PA28-181**  
S/N 28-7690001 thru 28-8690062,  
2843001 thru 2843999, 2890001 thru 2890231  
Complete Kit P/N PKCT181-01 (Manual Trim)  
Complete Kit P/N PKCT181-02 (Electric Trim)  
Stabilator Kit P/N PKCT-STAB-03 **1**

Qty	Part Number	Location
2	MC62701-099	Aileron Forward LH and RH
2	MC62701-122	Aileron Wing LH and RH
1	MC62701-123	Aileron Balance LH
1	MC62701-124	Aileron Balance RH
2	MC62701-100	Rudder Forward LH and RH
2	MC62701-008	Rudder Aft LH and RH
1	MC62701-113 <b>1</b>	Stabilator Forward LH
1	MC62701-114 <b>1</b>	Stabilator Forward RH
1	MC62701-012 <b>1</b>	Stabilator Aft Bottom
1	MC62701-013 <b>1</b>	Stabilator Aft Top
1	MC62701-101	Flap
1	MC62701-047	Stabilator Trim Aft
2	MC62701-104 <b>4</b>	Stab Trim Fwd LH and RH (Manual)
1	MC62701-111 <b>3</b>	Stabilator Trim Forward LH (Electric)

**PA28-235**  
S/N 28-10003 thru 28-10605  
Complete Kit P/N PKCT235-01  
Stabilator Kit P/N PKCT-STAB-01 **1**

Qty	Part Number	Location
2	MC62701-002	Aileron Forward LH and RH
2	MC62701-003	Aileron Wing LH and RH
1	MC62701-004	Aileron Balance LH
1	MC62701-005	Aileron Balance RH
2	MC62701-006	Rudder Forward LH and RH
2	MC62701-008	Rudder Aft LH and RH
1	MC62701-010 <b>1</b>	Stabilator Forward LH
1	MC62701-011 <b>1</b>	Stabilator Forward RH
1	MC62701-012 <b>1</b>	Stabilator Aft Bottom
1	MC62701-013 <b>1</b>	Stabilator Aft Top
1	MC62701-016	Stabilator Indicator Aft
1	MC62701-032	Stabilator Trim
1	MC62701-014	Flap

**PA28-235**  
S/N 28-10003 thru 28-10605  
with kit 756-896 or 756-930 installed  
Complete Kit P/N PKCT235-02  
Stabilator Kit P/N PKCT-STAB-01 **1**

Qty	Part Number	Location
2	MC62701-002	Aileron Forward LH and RH
2	MC62701-003	Aileron Wing LH and RH
1	MC62701-004	Aileron Balance LH
1	MC62701-005	Aileron Balance RH
2	MC62701-006	Rudder Forward LH and RH
2	MC62701-008	Rudder Aft LH and RH
1	MC62701-010 <b>1</b>	Stabilator Forward LH
1	MC62701-011 <b>1</b>	Stabilator Forward RH
1	MC62701-012 <b>1</b>	Stabilator Aft Bottom
1	MC62701-013 <b>1</b>	Stabilator Aft Top
1	MC62701-016	Stabilator Indicator Aft
1	MC62701-045	Stabilator Trim Forward (Manual)
1	MC62701-047	Stabilator Trim Aft
1	MC62701-014	Flap

**PA28-235**  
S/N 28-10606 thru 28-10719  
Complete Kit P/N PKCT235-03 (Manual Trim)  
Complete Kit P/N PKCT235-08 (Electric Trim)  
Stabilator Kit P/N PKCT-STAB-01 **1**

Qty	Part Number	Location
2	MC62701-002	Aileron Forward LH and RH
2	MC62701-003	Aileron Wing LH and RH
1	MC62701-004	Aileron Balance LH
1	MC62701-005	Aileron Balance RH
2	MC62701-006	Rudder Forward LH and RH
2	MC62701-008	Rudder Aft LH and RH
1	MC62701-010 <b>1</b>	Stabilator Forward LH
1	MC62701-011 <b>1</b>	Stabilator Forward RH
1	MC62701-012 <b>1</b>	Stabilator Aft Bottom
1	MC62701-013 <b>1</b>	Stabilator Aft Top
1	MC62701-016	Stabilator Indicator Aft
1	MC62701-045 <b>2</b>	Stabilator Trim Forward (Manual)
1	MC62701-047	Stabilator Trim Aft
1	MC62701-044 <b>3</b>	Stabilator Trim Forward (Electric)
1	MC62701-014	Flap

**PA28-235**  
S/N 28-10720 thru 28-11393  
28-7110001 thru 28-7210033  
Complete Kit P/N PKCT235-04 (Manual Trim)  
Complete Kit P/N PKCT235-05 (Electric Trim)  
Stabilator Kit P/N PKCT-STAB-01 **1**

Qty	Part Number	Location
2	MC62701-002	Aileron Forward LH and RH
2	MC62701-003	Aileron Wing LH and RH
1	MC62701-004	Aileron Balance LH
1	MC62701-005	Aileron Balance RH
2	MC62701-006	Rudder Forward LH and RH
2	MC62701-008	Rudder Aft LH and RH
1	MC62701-010 <b>1</b>	Stabilator Forward LH
1	MC62701-011 <b>1</b>	Stabilator Forward RH
1	MC62701-012 <b>1</b>	Stabilator Aft Bottom
1	MC62701-013 <b>1</b>	Stabilator Aft Top
1	MC62701-047	Stabilator Trim Aft
2	MC62701-056 <b>4</b>	Stab Trim Fwd LH and RH (Manual)
1	MC62701-057 <b>3</b>	Stabilator Trim Forward LH (Electric)
1	MC62701-014	Flap

**PA28-235**  
S/N 28-7310001 thru 28-7710089  
Complete Kit P/N PKCT235-06 (Manual Trim)  
Complete Kit P/N PKCT235-07 (Electric Trim)  
Stabilator Kit P/N PKCT-STAB-03 **1**

Qty	Part Number	Location
2	MC62701-099	Aileron Forward LH and RH
2	MC62701-003	Aileron Wing LH and RH
1	MC62701-004	Aileron Balance LH
1	MC62701-005	Aileron Balance RH
2	MC62701-100	Rudder Forward LH and RH
2	MC62701-008	Rudder Aft LH and RH
1	MC62701-113 <b>1</b>	Stabilator Forward LH
1	MC62701-114 <b>1</b>	Stabilator Forward RH
1	MC62701-012 <b>1</b>	Stabilator Aft Bottom
1	MC62701-013 <b>1</b>	Stabilator Aft Top
1	MC62701-047	Stabilator Trim Aft
2	MC62701-104 <b>4</b>	Stab Trim Fwd LH and RH (Manual)
1	MC62701-111 <b>3</b>	Stabilator Trim Forward LH (Electric)
1	MC62701-101	Flap

**PA28-236**  
S/N 28-7911001 thru 28-8611008,  
2811001 thru 2811050  
Complete Kit P/N PKCT236-01 (Manual Trim)  
Complete Kit P/N PKCT236-02 (Electric Trim)  
Stabilator Kit P/N PKCT-STAB-03 **1**

Qty	Part Number	Location
2	MC62701-099	Aileron Forward LH and RH
2	MC62701-122	Aileron Wing LH and RH
1	MC62701-123	Aileron Balance LH
1	MC62701-124	Aileron Balance RH
2	MC62701-100	Rudder Forward LH and RH
2	MC62701-008	Rudder Aft LH and RH
1	MC62701-113 <b>1</b>	Stabilator Forward LH
1	MC62701-114 <b>1</b>	Stabilator Forward RH
1	MC62701-012 <b>1</b>	Stabilator Aft Bottom
1	MC62701-013 <b>1</b>	Stabilator Aft Top
1	MC62701-101	Flap
1	MC62701-047	Stabilator Trim Aft
2	MC62701-104 <b>4</b>	Stab Trim Fwd LH and RH (Manual)
1	MC62701-111 <b>3</b>	Stabilator Trim Forward LH (Electric)

**1** Stabilator kits to assist with Piper AD2013-02-13 include cables designated with **1** plus 2 each MS21251-B5S Barrels and 10 each MS21256-1 Locking Clips.  
**2** Included in kits for manual trim aircraft only.  
**3** Included in kits for electric trim aircraft only.  
**4** Kits for electric trim aircraft include only one of this part number.



FAA-PMA Approved

**PA28-201T**  
S/N 28-7921001 thru 28-7921095  
Complete Kit P/N PKCT201T-01 (Manual Trim)  
Complete Kit P/N PKCT201T-02 (Electric Trim)  
Stabilator Kit P/N PKCT-STAB-03 **1**

Qty	Part Number	Location
2	MC62701-099	Aileron Forward LH and RH
2	MC62701-122	Aileron Wing LH and RH
1	MC62701-123	Aileron Balance LH
1	MC62701-124	Aileron Balance RH
1	MC62701-100	Rudder Forward LH and RH
2	MC62701-008	Rudder Aft LH and RH
1	MC62701-113 <b>1</b>	Stabilator Forward LH
1	MC62701-114 <b>1</b>	Stabilator Forward RH
1	MC62701-012 <b>1</b>	Stabilator Aft Bottom
1	MC62701-013 <b>1</b>	Stabilator Aft Top
1	MC62701-101	Flap
1	MC62701-047	Stabilator Trim Aft
2	MC62701-104 <b>4</b>	Stab Trim Fwd LH and RH (Manual)
1	MC62701-111 <b>3</b>	Stabilator Trim Forward LH (Electric)

**PA28R-180**  
S/N 28R-30005 thru 28R-30481,  
28R-30483 thru 28R-31279,  
28R-7130001 thru 28R-7130019  
Complete Kit P/N PKCTR180-01 (Manual Trim)  
Complete Kit P/N PKCTR180-02 (Electric Trim)  
Stabilator Kit P/N PKCT-STAB-04 **1**

Qty	Part Number	Location
2	MC62701-002	Aileron Forward LH and RH
2	MC62701-003	Aileron Wing LH and RH
1	MC62701-004	Aileron Balance LH
1	MC62701-005	Aileron Balance RH
2	MC62701-006	Rudder Forward LH and RH
2	MC62701-064	Aft Rudder LH and RH
1	MC62701-062 <b>1</b>	Stabilator Fwd LH
1	MC62701-061 <b>1</b>	Stabilator Fwd RH
1	MC62701-012 <b>1</b>	Stabilator Aft Bottom
1	MC62701-013 <b>1</b>	Stabilator Aft Top
1	MC62701-014	Flap
1	MC62701-047	Stabilator Trim Aft
2	MC62701-056 <b>4</b>	Stab Trim Fwd LH and RH (Manual)
1	MC62701-057 <b>3</b>	Stabilator Trim Forward LH (Electric)

**PA28R-200**  
S/N 28R-35001 thru 28R-35830,  
28R-7135001 thru 28R-7135238  
Complete Kit P/N PKCTR200-01 (Manual Trim)  
Complete Kit P/N PKCTR200-02 (Electric Trim)  
Stabilator Kit P/N PKCT-STAB-04 **1**

Qty	Part Number	Location
2	MC62701-002	Aileron Forward LH and RH
2	MC62701-003	Aileron Wing LH and RH
1	MC62701-004	Aileron Balance LH
1	MC62701-005	Aileron Balance RH
2	MC62701-006	Rudder Forward LH and RH
2	MC62701-064	Rudder Aft LH and RH
1	MC62701-062 <b>1</b>	Stabilator Fwd LH
1	MC62701-061 <b>1</b>	Stabilator Fwd RH
1	MC62701-012 <b>1</b>	Stabilator Aft Bottom
1	MC62701-013 <b>1</b>	Stabilator Aft Top
1	MC62701-014	Flap
1	MC62701-047	Stabilator Trim Aft
2	MC62701-056 <b>4</b>	Stab Trim Fwd LH and RH (Manual)
1	MC62701-057 <b>3</b>	Stabilator Trim Forward LH (Electric)

**PA28R-200**  
S/N 28R-7235001 thru 28R-7635545  
Complete Kit P/N PKCTR200-03 (Manual Trim)  
Complete Kit P/N PKCTR200-04 (Electric Trim)  
Stabilator Kit P/N PKCT-STAB-05 **1**

Qty	Part Number	Location
2	MC62701-099	Aileron Forward LH and RH
2	MC62701-003	Aileron Wing LH and RH
1	MC62701-004	Aileron Balance LH
1	MC62701-005	Aileron Balance RH
2	MC62701-100	Rudder Forward LH and RH
2	MC62701-064	Rudder Aft LH and RH
1	MC62701-103 <b>1</b>	Stabilator Forward LH
1	MC62701-102 <b>1</b>	Stabilator Forward RH
1	MC62701-012 <b>1</b>	Stabilator Aft Bottom
1	MC62701-013 <b>1</b>	Stabilator Aft Top
1	MC62701-101	Flap
1	MC62701-047	Stabilator Trim Aft
2	MC62701-104 <b>4</b>	Stab Trim Fwd LH and RH (Manual)
1	MC62701-111 <b>3</b>	Stabilator Trim Forward LH (Electric)

**PA28R-201**  
S/N 28R-7737002 thru 28R-7837317,  
2837001 thru 2837061  
Complete Kit P/N PKCTR201-01 (Manual Trim)  
Complete Kit P/N PKCTR201-02 (Electric Trim)  
Stabilator Kit P/N PKCT-STAB-05 **1**

Qty	Part Number	Location
2	MC62701-099	Aileron Forward LH and RH
2	MC62701-143	Aileron Wing LH and RH
1	MC62701-123	Aileron Balance LH
1	MC62701-124	Aileron Balance RH

Kit continues in next column

Continued from previous column

Qty	Part Number	Location
2	MC62701-100	Rudder Forward LH and RH
2	MC62701-064	Rudder Aft LH and RH
1	MC62701-103 <b>1</b>	Stabilator Forward LH
1	MC62701-102 <b>1</b>	Stabilator Forward RH
1	MC62701-012 <b>1</b>	Stabilator Aft Bottom
1	MC62701-013 <b>1</b>	Stabilator Aft Top
1	MC62701-101	Flap
1	MC62701-047	Stabilator Trim Aft
2	MC62701-104 <b>4</b>	Stab Trim Fwd LH and RH (Manual)
1	MC62701-111 <b>3</b>	Stabilator Trim Forward LH (Electric)

**PA28R-201T**  
S/N 28R-7703002 thru 28R-7803372,  
2803001 thru 2803015  
Complete Kit P/N PKCTR201T-01 (Manual Trim)  
Complete Kit P/N PKCTR201T-02 (Electric Trim)  
Stabilator Kit P/N PKCT-STAB-05 **1**

Qty	Part Number	Location
2	MC62701-099	Aileron Forward LH and RH
2	MC62701-143	Aileron Wing LH and RH
1	MC62701-123	Aileron Balance LH
1	MC62701-124	Aileron Balance RH
2	MC62701-100	Rudder Forward LH and RH
2	MC62701-064	Rudder Aft LH and RH
1	MC62701-103 <b>1</b>	Stabilator Forward LH
1	MC62701-102 <b>1</b>	Stabilator Forward RH
1	MC62701-012 <b>1</b>	Stabilator Aft Bottom
1	MC62701-013 <b>1</b>	Stabilator Aft Top
1	MC62701-101	Flap
1	MC62701-047	Stabilator Trim Aft
2	MC62701-104 <b>4</b>	Stab Trim Fwd LH and RH (Manual)
1	MC62701-111 <b>3</b>	Stabilator Trim Forward LH (Electric)

**PA28RT-201**  
S/N 28R-7918001 thru 28R-8218026  
Complete Kit P/N PKCTR201T-01 (Manual Trim)  
Complete Kit P/N PKCTR201T-02 (Electric Trim)  
Stabilator Kit P/N PKCT-STAB-06 **1**

Qty	Part Number	Location
2	MC62701-099	Aileron Forward LH and RH
2	MC62701-143	Aileron Wing LH and RH
1	MC62701-123	Aileron Balance LH
1	MC62701-124	Aileron Balance RH
1	MC62701-101	Flap
1	MC62701-102 <b>1</b>	Stabilator Forward RH
1	MC62701-103 <b>1</b>	Stabilator Forward LH
1	MC62701-169 <b>1</b>	Stabilator Aft Upper
1	MC62701-170 <b>1</b>	Stabilator Aft Lower
2	MC62701-189 <b>4</b>	Stab Trim Fwd LH and RH (Manual)
1	MC62701-155	Stabilator Trim Aft
2	MC62701-100	Rudder Forward LH and RH
1	MC62701-168	Rudder Aft
1	MC62701-191 <b>3</b>	Stabilator Trim Fwd LH (Electric)

**PA28RT-201**  
S/N 28R-7918001 thru 28R-8218026  
For aircraft with Altimatic IIIC Autopilot  
Complete Kit P/N PKCTR201-04 (Electric Trim)  
Stabilator Kit P/N PKCT-STAB-06 **1**

Qty	Part Number	Location
2	MC62701-099	Aileron Forward LH and RH
2	MC62701-143	Aileron Wing LH and RH
1	MC62701-123	Aileron Balance LH
1	MC62701-124	Aileron Balance RH
1	MC62701-101	Flap
1	MC62701-102 <b>1</b>	Stabilator Forward RH
1	MC62701-103 <b>1</b>	Stabilator Forward LH
1	MC62701-169 <b>1</b>	Stabilator Aft Upper
1	MC62701-170 <b>1</b>	Stabilator Aft Lower
2	MC62701-189 <b>4</b>	Stab Trim Fwd LH and RH (Manual)
1	MC62701-155	Stabilator Trim Aft
2	MC62701-100	Rudder Forward RH
1	MC62701-168	Rudder Aft
1	MC62701-193	Stab Trim Fwd LH (Autopilots)

**PA28RT-201T**  
S/N 28R-7931001 thru 28R-8631005,  
2831001 thru 2831038  
Complete Kit P/N PKCTR201T-01 (Manual Trim)  
Complete Kit P/N PKCTR201T-02 (Electric Trim)  
Stabilator Kit P/N PKCT-STAB-06 **1**

Qty	Part Number	Location
2	MC62701-099	Aileron Forward LH and RH
2	MC62701-143	Aileron Wing LH and RH
1	MC62701-123	Aileron Balance LH
1	MC62701-124	Aileron Balance RH
1	MC62701-101	Flap
1	MC62701-102 <b>1</b>	Stabilator Forward RH
1	MC62701-103 <b>1</b>	Stabilator Forward LH
1	MC62701-169 <b>1</b>	Stabilator Aft Upper
1	MC62701-170 <b>1</b>	Stabilator Aft Lower
2	MC62701-189 <b>4</b>	Stab Trim Fwd LH and RH (Manual)
1	MC62701-155	Stabilator Trim Aft
2	MC62701-100	Rudder Forward LH and RH
1	MC62701-168	Rudder Aft
1	MC62701-191 <b>3</b>	Stabilator Trim Fwd LH (Electric)

**PA28RT-201T**  
S/N 28R-7931001 thru 28R-8631005,  
2831001 thru 2831038  
For aircraft with Altimatic IIIC Autopilot  
Complete Kit P/N PKCTR201T-04 (Electric Trim)  
Stabilator Kit P/N PKCT-STAB-06 **1**

Qty	Part Number	Location
2	MC62701-099	Aileron Forward LH and RH
2	MC62701-143	Aileron Wing LH and RH
1	MC62701-123	Aileron Balance LH
1	MC62701-124	Aileron Balance RH
1	MC62701-101	Flap
1	MC62701-102 <b>1</b>	Stabilator Forward RH
1	MC62701-103 <b>1</b>	Stabilator Forward LH
1	MC62701-169 <b>1</b>	Stabilator Aft Upper
1	MC62701-170 <b>1</b>	Stabilator Aft Lower
1	MC62701-189 <b>2</b>	Stab Trim Fwd RH
1	MC62701-155	Stabilator Trim Aft
2	MC62701-100	Rudder Forward LH and RH
1	MC62701-168	Rudder Aft
1	MC62701-193	Stab Trim Fwd LH (Autopilots)

**PA28S-180**  
S/N 28S-671 thru 28S-2171  
Complete Kit P/N PKCTS180-01  
Stabilator Kit P/N PKCT-STAB-02 **1**

Qty	Part Number	Location
2	MC62701-018	Aileron Wing LH and RH
1	MC62701-019	Aileron Balance LH
1	MC62701-020	Aileron Balance RH
2	MC62701-017	Aileron Forward LH and RH
2	MC62701-023	Rudder Aft LH and RH
1	MC62701-027 <b>1</b>	Stabilator Aft LH
1	MC62701-028 <b>1</b>	Stabilator Aft RH
1	MC62701-031	Stabilator Trim Aft
1	MC62701-046 <b>2</b>	Stabilator Trim Forward LH (Manual)
1	MC62701-049 <b>3</b>	Stabilator Trim Forward LH (Electric)

**PA28S-180**  
S/N 28S-2172 thru 28S-5869,  
28S-7105001 thru 28S-7205234  
Complete Kit P/N PKCTS180-02 (Manual Trim)  
Complete Kit P/N PKCTS180-03 (Electric Trim)  
Stabilator Kit P/N PKCT-STAB-02 **1**

Qty	Part Number	Location
2	MC62701-018	Aileron Wing LH and RH
1	MC62701-019	Aileron Balance LH
1	MC62701-020	Aileron Balance RH
2	MC62701-017	Aileron Forward LH and RH
2	MC62701-023	Rudder Aft LH and RH
1	MC62701-027 <b>1</b>	Stabilator Aft LH
1	MC62701-028 <b>1</b>	Stabilator Aft RH
1	MC62701-031	Stabilator Trim Aft
1	MC62701-046 <b>2</b>	Stabilator Trim Forward LH (Manual)
1	MC62701-049 <b>3</b>	Stabilator Trim Forward LH (Electric)

**PA32-260**  
S/N 32-1 thru 32-1320,  
32-7100001 thru 32-7300076  
Complete Kit P/N PKCT260-01 (Manual Trim)  
Complete Kit P/N PKCT260-02 (Electric Trim)  
Stabilator Kit P/N PKCT-STAB-07 **1**

Qty	Part Number	Location
2	MC62701-008	Rudder Aft LH and RH
2	MC62701-036	Aileron Forward LH and RH
2	MC62701-003	Aileron Wing LH and RH
1	MC62701-048	Aileron Balance LH
1	MC62701-005	Aileron Balance RH
2	MC62701-037 <b>1</b>	Rudder Fwd RH/Stabilator Fwd RH
1	MC62701-038	Rudder Forward LH
1	MC62701-040 <b>1</b>	Stabilator Forward LH
1	MC62701-012 <b>1</b>	Stabilator Aft LH
1	MC62701-013 <b>1</b>	Stabilator Aft RH
2	MC62701-041 <b>4</b>	Stab Trim Fwd LH and RH (Manual)
1	MC62701-042 <b>3</b>	Stabilator Trim Forward LH (Electric)
1	MC62701-047	Stabilator Trim Aft
1	MC62701-014	Flap

**PA32-260**  
S/N 32-7400001 thru 32-7400061  
Complete Kit P/N PKCT260-03 (Manual Trim)  
Complete Kit P/N PKCT260-04 (Electric Trim)  
Stabilator Kit P/N PKCT-STAB-07 **1**

Qty	Part Number	Location
1	MC62701-134	Rudder Aft LH
1	MC62701-008	Rudder Aft RH
1	MC62701-012 <b>1</b>	Stabilator Aft LH
1	MC62701-013 <b>1</b>	Stabilator Aft RH
2	MC62701-036	Aileron Forward LH and RH
2	MC62701-003	Aileron Wing LH and RH
1	MC62701-048	Aileron Balance LH
1	MC62701-005	Aileron Balance RH

Kit continues on next page

**1** Stabilator kits to assist with Piper AD2013-02-13 include cables designated with **1** plus 2 each MS21251-B5S Barrels and 10 each MS21256-1 Locking Clips.

**2** Included in kits for manual trim aircraft only.

**3** Included in kits for electric trim aircraft only.

**4** Kits for electric trim aircraft include only one of this part number.

Flight Control System

# Flight Control System

## Flight Control Cables - Piper

**Continued from previous page**

Qty	Part Number	Location
2	MC62701-037 <b>1</b>	Rudder Fwd RH/Stabilator Fwd RH
1	MC62701-038	Rudder Forward LH
1	MC62701-040 <b>1</b>	Stabilator Forward LH
2	MC62701-041 <b>1</b>	Stab Trim Fwd LH and RH (Manual)
1	MC62701-042 <b>3</b>	Stabilator Trim Forward LH (Electric)
1	MC62701-047	Stabilator Trim Aft
1	MC62701-014	Flap

**PA32-260**  
S/N 32-7500001 thru 32-7800008  
Complete Kit P/N PKCT260-05 (Manual Trim)  
Complete Kit P/N PKCT260-06 (Electric Trim)  
Stabilator Kit P/N PKCT-STAB-07 **1**

Qty	Part Number	Location
2	MC62701-008	Rudder Aft LH and RH
1	MC62701-012 <b>1</b>	Stabilator Aft LH
1	MC62701-013 <b>1</b>	Stabilator Aft RH
2	MC62701-036	Aileron Forward LH and RH
2	MC62701-003	Aileron Wing LH and RH
1	MC62701-048	Aileron Balance LH
1	MC62701-005	Aileron Balance RH
3	MC62701-037 <b>1</b>	Rudder Fwd LH&RH/Stab Fwd RH
1	MC62701-040 <b>1</b>	Stabilator Forward LH
2	MC62701-041 <b>4</b>	Stab Trim Fwd LH and RH (Manual)
1	MC62701-042 <b>3</b>	Stabilator Trim Forward LH (Electric)
1	MC62701-047	Stabilator Trim Aft
1	MC62701-014	Flap

**PA32-300**  
S/N 32-40000 thru 32-41018,  
32-7140001 thru 32-7340201  
Complete Kit P/N PKCT300-01 (Manual Trim)  
Complete Kit P/N PKCT300-02 (Electric Trim)  
Stabilator Kit P/N PKCT-STAB-07 **1**

Qty	Part Number	Location
2	MC62701-008	Rudder Aft LH and RH
1	MC62701-012 <b>1</b>	Stabilator Aft LH
1	MC62701-013 <b>1</b>	Stabilator Aft RH
2	MC62701-036	Aileron Forward LH and RH
2	MC62701-003	Aileron Wing LH and RH
1	MC62701-048	Aileron Balance
1	MC62701-005	Aileron Balance RH
2	MC62701-037 <b>1</b>	Rudder Fwd RH/Stab Fwd RH
1	MC62701-038	Rudder Forward LH
1	MC62701-040 <b>1</b>	Stabilator Forward LH
2	MC62701-041 <b>4</b>	Forward Stabilator Trim
1	MC62701-042 <b>3</b>	Electric Trim
1	MC62701-047	Stabilator Trim Aft
1	MC62701-014	Flap

**PA32-300**  
S/N 32-7440001 thru 32-7440182  
Complete Kit P/N PKCT300-03 (Manual Trim)  
Complete Kit P/N PKCT300-04 (Electric Trim)  
Stabilator Kit P/N PKCT-STAB-07 **1**

Qty	Part Number	Location
1	MC62701-134	Rudder Aft LH
1	MC62701-008	Rudder Aft RH
1	MC62701-012 <b>1</b>	Stabilator Aft LH
1	MC62701-013 <b>1</b>	Stabilator Aft RH
2	MC62701-036	Aileron Forward LH and RH
2	MC62701-003	Aileron Wing LH and RH
1	MC62701-048	Aileron Balance LH
1	MC62701-005	Aileron Balance RH
2	MC62701-037 <b>1</b>	Rudder Fwd RH/Stab Fwd RH
1	MC62701-038	Rudder Forward LH
1	MC62701-040 <b>1</b>	Stabilator Forward LH
2	MC62701-041 <b>4</b>	Stab Trim Fwd LH and RH (Manual)
1	MC62701-042 <b>3</b>	Stabilator Trim Forward LH (Electric)
1	MC62701-047	Stabilator Trim Aft
1	MC62701-014	Flap

**PA32-300**  
S/N 32-7540001 thru 32-7940282  
Complete Kit P/N PKCT300-05 (Manual Trim)  
Complete Kit P/N PKCT300-06 (Electric Trim)  
Stabilator Kit P/N PKCT-STAB-07 **1**

Qty	Part Number	Location
2	MC62701-008	Rudder Aft LH and RH
1	MC62701-012 <b>1</b>	Stabilator Aft LH
1	MC62701-013 <b>1</b>	Stabilator Aft RH
2	MC62701-036	Aileron Forward LH and RH
2	MC62701-003	Aileron Wing LH and RH
1	MC62701-048	Aileron Balance LH
1	MC62701-005	Aileron Balance RH
3	MC62701-037 <b>1</b>	Rudd Fwd LH & RH/Stab Fwd RH
1	MC62701-040 <b>1</b>	Stabilator Forward LH
2	MC62701-041 <b>4</b>	Stab Trim Fwd LH and RH (Manual)
1	MC62701-042 <b>3</b>	Stabilator Trim Forward LH (Electric)
1	MC62701-047	Stabilator Trim Aft
1	MC62701-014	Flap

**PA32-301**  
S/N 32-8006001 thru 32-8606023, 3206001 thru 3206060  
Complete Kit P/N PKCT301-01 (Manual Trim)  
Complete Kit P/N PKCT301-02 (Electric Trim)  
Stabilator Kit P/N PKCT-STAB-09 **1**

Qty	Part Number	Location
2	MC62701-036	Aileron Forward LH and RH
2	MC62701-202	Aileron Wing LH and RH
1	MC62701-200	Aileron Balance LH
1	MC62701-201	Aileron Balance RH
1	MC62701-014	Flap
1	MC62701-208 <b>1</b>	Stabilator Aft LH
1	MC62701-205 <b>1</b>	Stabilator Aft RH
1	MC62701-207 <b>1</b>	Stabilator Forward LH
1	MC62701-047	Stabilator Trim Aft
2	MC62701-041 <b>4</b>	Stab Trim Fwd LH and RH (Manual)
1	MC62701-042 <b>3</b>	Stabilator Trim Forward LH (Electric)
2	MC62701-008	Rudder Aft LH and RH
3	MC62701-037 <b>1</b>	Rudd Fwd LH & RH/Stab Fwd RH

**PA32-301**  
S/N 32-8406001 thru 32-8606023, 3206001 thru 3206060  
For aircraft with Century 31 Autopilot  
Complete Kit P/N PKCT301-04 (Electric Trim)  
Stabilator Kit P/N PKCT-STAB-09 **1**

Qty	Part Number	Location
2	MC62701-036	Aileron Forward LH and RH
2	MC62701-202	Aileron Wing LH and RH
1	MC62701-200	Aileron Balance LH
1	MC62701-201	Aileron Balance RH
1	MC62701-014	Flap
1	MC62701-208 <b>1</b>	Stabilator Aft LH
1	MC62701-205 <b>1</b>	Stabilator Aft RH
1	MC62701-207 <b>1</b>	Stabilator Forward LH
1	MC62701-047	Stabilator Trim Aft
1	MC62701-041 <b>2</b>	Stab Trim Fwd RH
1	MC62701-135	Stabilator Trim Forward
2	MC62701-008	Rudder Aft LH and RH
3	MC62701-037 <b>1</b>	Rudd Fwd LH & RH/Stab Fwd RH

**PA32-301T**  
S/N 32-8024001 thru 32-8424002  
Complete Kit P/N PKCT301T-01 (Manual Trim)  
Complete Kit P/N PKCT301T-02 (Electric Trim)  
Stabilator Kit P/N PKCT-STAB-09 **1**

Qty	Part Number	Location
2	MC62701-036	Aileron Forward LH and RH
2	MC62701-202	Aileron Wing LH and RH
1	MC62701-200	Aileron Balance LH
1	MC62701-201	Aileron Balance RH
1	MC62701-014	Flap
1	MC62701-207 <b>1</b>	Stabilator Forward LH
1	MC62701-208 <b>1</b>	Stabilator Aft LH
1	MC62701-205 <b>1</b>	Stabilator Aft RH
1	MC62701-047	Stabilator Trim Aft
2	MC62701-041 <b>4</b>	Stab Trim Fwd LH and RH (Manual)
3	MC62701-037 <b>1</b>	Rudd Fwd LH & RH/Stab Fwd RH
2	MC62701-008	Rudder Aft LH and RH
1	MC62701-042 <b>3</b>	Stabilator Trim Forward LH (Electric)

**PA32-301T**  
S/N S/N 32-8024001 thru 32-8424002  
For aircraft with Century 31 Autopilot  
Complete Kit P/N PKCT301T-04 (Electric Trim)  
Stabilator Kit P/N PKCT-STAB-09 **1**

Qty	Part Number	Location
2	MC62701-036	Aileron Forward LH and RH
2	MC62701-202	Aileron Wing LH and RH
1	MC62701-200	Aileron Balance LH
1	MC62701-201	Aileron Balance RH
1	MC62701-014	Flap
1	MC62701-207 <b>1</b>	Stabilator Forward LH
1	MC62701-208 <b>1</b>	Stabilator Aft LH
1	MC62701-205 <b>1</b>	Stabilator Aft RH
1	MC62701-047	Stabilator Trim Aft
1	MC62701-041	Stab Trim Fwd RH
3	MC62701-037 <b>1</b>	Rudd Fwd LH & RH/Stab Fwd RH
2	MC62701-008	Rudder Aft LH and RH
1	MC62701-135	Stabilator Trim Fwd LH (Autopilot)

**PA32R-300**  
S/N 32R-7680001 thru 32R-7880068  
Complete Kit P/N PKCTR300-01 (Manual Trim)  
Complete Kit P/N PKCTR300-02 (Electric Trim)  
Stabilator Kit P/N PKCT-STAB-07 **1**

Qty	Part Number	Location
2	MC62701-008	Rudder Aft LH and RH
1	MC62701-012 <b>1</b>	Stabilator Aft LH
1	MC62701-013 <b>1</b>	Stabilator Aft RH
2	MC62701-036	Aileron Forward LH and RH
2	MC62701-003	Aileron Wing LH and RH
1	MC62701-048	Aileron Balance LH
1	MC62701-005	Aileron Balance RH
3	MC62701-037 <b>1</b>	Rudd Fwd LH & RH/Stab Fwd RH
1	MC62701-040 <b>1</b>	Stabilator Forward LH
2	MC62701-041 <b>4</b>	Stab Trim Fwd LH and RH (Manual)
1	MC62701-042 <b>3</b>	Stabilator Trim Forward LH (Electric)
1	MC62701-047	Stabilator Trim Aft
1	MC62701-014	Flap

**PA32R-301**  
S/N 32R-8013001 thru 32R-8613006,  
3213001 thru 3213103  
Complete Kit P/N PKCTR301-01 (Manual Trim)  
Complete Kit P/N PKCTR301-02 (Electric Trim)  
Stabilator Kit P/N PKCT-STAB-09 **1**

Qty	Part Number	Location
2	MC62701-036	Aileron Forward LH and RH
2	MC62701-199	Aileron Wing LH and RH
1	MC62701-200	Aileron Balance LH
1	MC62701-201	Aileron Balance RH
1	MC62701-014	Flap
1	MC62701-207 <b>1</b>	Stabilator Forward LH
1	MC62701-205 <b>1</b>	Stabilator Aft RH
1	MC62701-208 <b>1</b>	Stabilator Aft LH
1	MC62701-047	Stabilator Trim Aft
2	MC62701-041 <b>4</b>	Stab Trim Fwd LH and RH (Manual)
3	MC62701-037 <b>1</b>	Rudd Fwd LH & RH/Stab Fwd RH
2	MC62701-008	Rudder Aft LH and RH
1	MC62701-042 <b>3</b>	Stabilator Trim Forward LH (Electric)

**PA32R-301T**  
S/N 32R-8029001 thru 32R-8629008,  
3229001 thru 3229003  
Complete Kit P/N PKCTR301T-01 (Manual Trim)  
Complete Kit P/N PKCTR301T-02 (Electric Trim)  
Stabilator Kit P/N PKCT-STAB-09 **1**

Qty	Part Number	Location
2	MC62701-036	Aileron Forward LH and RH
2	MC62701-199	Aileron Wing LH and RH
1	MC62701-200	Aileron Balance LH
1	MC62701-201	Aileron Balance RH
1	MC62701-014	Flap
1	MC62701-207 <b>1</b>	Stabilator Forward LH
1	MC62701-205 <b>1</b>	Stabilator Aft RH
1	MC62701-208 <b>1</b>	Stabilator Aft LH
1	MC62701-047	Stabilator Trim Aft
2	MC62701-041 <b>4</b>	Stab Trim Fwd LH and RH (Manual)
3	MC62701-037 <b>1</b>	Rudd Fwd LH & RH/Stab Fwd RH
2	MC62701-008	Rudder Aft LH and RH
1	MC62701-042 <b>3</b>	Stabilator Trim Forward LH (Electric)

**PA32RT-300**  
S/N 32R-7885001 thru 32R-7985125  
Complete Kit P/N PKCTR300-01 (Manual Trim)  
Complete Kit P/N PKCTR300-02 (Electric Trim)  
Stabilator Kit P/N PKCT-STAB-10 **1**

Qty	Part Number	Location
2	MC62701-036	Aileron Forward LH and RH
2	MC62701-003	Aileron Wing LH and RH
1	MC62701-048	Aileron Balance LH
1	MC62701-005	Aileron Balance RH
3	MC62701-037 <b>1</b>	Rudd Fwd LH & RH/Stab Fwd RH
1	MC62701-157	Rudder Aft
1	MC62701-040 <b>1</b>	Stabilator Forward LH
1	MC62701-159 <b>1</b>	Stabilator Aft LH
1	MC62701-158 <b>1</b>	Stabilator Aft RH
2	MC62701-041 <b>4</b>	Stab Trim Fwd LH and RH (Manual)
1	MC62701-137	Stabilator Trim Aft
1	MC62701-014	Flap

**PA32RT-300**  
S/N 32R-7885001 thru 32R-7985013,  
For aircraft with Altimatec IIIC Autopilot  
Complete Kit P/N PKCTR300-05 (Electric Trim)  
Stabilator Kit P/N PKCT-STAB-10 **1**

Qty	Part Number	Location
2	MC62701-036	Aileron Forward LH and RH
2	MC62701-003	Aileron Wing LH and RH
1	MC62701-048	Aileron Balance LH
1	MC62701-005	Aileron Balance RH
3	MC62701-037 <b>1</b>	Rudd Fwd LH & RH/Stab Fwd RH
1	MC62701-157	Rudder Aft
1	MC62701-040 <b>1</b>	Stabilator Forward LH
1	MC62701-159 <b>1</b>	Stabilator Aft LH
1	MC62701-158 <b>1</b>	Stabilator Aft RH
1	MC62701-041	Stab Trim Fwd RH
1	MC62701-137	Stabilator Trim Aft
1	MC62701-135	Stab Trim Fwd LH & RH (Autopilot)
1	MC62701-014	Flap

**PA32RT-300**  
S/N 32R-7985014 thru 32R-7985125,  
For aircraft with Altimatec IIIC Autopilot  
Complete Kit P/N PKCTR300-06 (Electric Trim)  
Stabilator Kit P/N PKCT-STAB-10 **1**

Qty	Part Number	Location
2	MC62701-036	Aileron Forward LH and RH
2	MC62701-003	Aileron Wing LH and RH
1	MC62701-048	Aileron Balance LH
1	MC62701-005	Aileron Balance RH

**Kit continues on next page**  
**1** Stabilator kits to assist with Piper AD2013-02-13 include cables designated with **1** plus 2 each MS21251-B5S Barrels and 10 each MS21256-1 Locking Clips.  
**2** Included in kits for manual trim aircraft only.  
**3** Included in kits for electric trim aircraft only.  
**4** Kits for electric trim aircraft include only one of this part number.





FAA-PMA Approved

**Continued from previous page**

Qty	Part Number	Location
3	MC62701-037	Rudd Fwd LH & RH/Stab Fwd RH
1	MC62701-157	Rudder Aft
1	MC62701-040	Stabilator Forward LH
1	MC62701-159	Stabilator Aft LH
1	MC62701-158	Stabilator Aft RH
1	MC62701-041	Stab Trim Fwd RH
2	MC62701-137	Stabilator Trim Aft
1	MC62701-183	Stab Trim Fwd LH & RH (Autopilot)

**PA32RT-300T**  
 S/N 32R-7887001 thru 32R-7987146  
 Complete Kit P/N PCKTRT300T-01 (Manual Trim)  
 Complete Kit P/N PCKTRT300T-02 (Electric Trim)  
 Stabilator Kit P/N PCKT-STAB-10

Qty	Part Number	Location
2	MC62701-036	Aileron Forward LH and RH
2	MC62701-003	Aileron Wing LH and RH
1	MC62701-048	Aileron Balance LH
1	MC62701-005	Aileron Balance RH
3	MC62701-037	Rudd Fwd LH & RH/Stab Fwd RH
1	MC62701-157	Rudder Aft
1	MC62701-040	Stabilator Forward LH
1	MC62701-159	Stabilator Aft LH
1	MC62701-158	Stabilator Aft RH
2	MC62701-041	Stab Trim Fwd RH
1	MC62701-137	Stabilator Trim Aft
1	MC62701-042	Stabilator Trim Fwd LH (Electric)

**PA32RT-300T**  
 S/N 32R-7887003, 32R-7887005 thru 32R-7887050,  
 For aircraft with Altimatic IIIC Autopilot  
 32R-7887052 thru 32R-7887307,  
 32R-7987001 thru 32R-7987035  
 Complete Kit P/N PCKTRT300T-05 (Electric Trim)  
 Stabilator Kit P/N PCKT-STAB-10

Qty	Part Number	Location
2	MC62701-036	Aileron Forward LH and RH
2	MC62701-003	Aileron Wing LH and RH
1	MC62701-048	Aileron Balance LH
1	MC62701-005	Aileron Balance RH
3	MC62701-037	Rudd Fwd LH & RH/Stab Fwd RH
1	MC62701-157	Rudder Aft
1	MC62701-040	Stabilator Forward LH
1	MC62701-159	Stabilator Aft LH
1	MC62701-158	Stabilator Aft RH
1	MC62701-041	Stab Trim Fwd RH
1	MC62701-137	Stabilator Trim Aft
1	MC62701-135	Stab Trim Fwd LH & RH (Autopilot)

**PA32RT-300T**  
 S/N 32R-7987004, 32R-7987051,  
 32R-7987036 thru 32R-7987146  
 For aircraft with Altimatic IIIC Autopilot  
 Complete Kit P/N PCKTRT300T-06 (Electric Trim)  
 Stabilator Kit P/N PCKT-STAB-10

Qty	Part Number	Location
2	MC62701-036	Aileron Forward LH and RH
2	MC62701-003	Aileron Wing LH and RH
1	MC62701-048	Aileron Balance LH
1	MC62701-005	Aileron Balance RH
3	MC62701-037	Rudd Fwd LH & RH/Stab Fwd RH
1	MC62701-157	Rudder Aft
1	MC62701-040	Stabilator Forward LH
1	MC62701-159	Stabilator Aft LH
1	MC62701-158	Stabilator Aft RH
1	MC62701-041	Stab Trim Fwd RH
1	MC62701-137	Stabilator Trim Aft
1	MC62701-183	Stab Trim Fwd LH & RH (Autopilot)

**PA32S-300**  
 S/N 32S-40000 thru 32S-7240147  
 Complete Kit P/N PCKTS300-01 (Manual Trim)  
 Complete Kit P/N PCKTS300-02 (Electric Trim)  
 Stabilator Kit P/N PCKT-STAB-08

Qty	Part Number	Location
2	MC62701-023	Rudder Aft LH and RH
2	MC62701-051	Rudder Fwd RH/Stab Fwd RH
1	MC62701-037	Rudder Forward LH
1	MC62701-027	Stabilator Aft LH
1	MC62701-028	Stabilator Aft RH
1	MC62701-053	Stabilator Forward LH
2	MC62701-050	Aileron Forward LH and RH
2	MC62701-018	Aileron Wing LH and RH
1	MC62701-055	Aileron Balance LH
1	MC62701-020	Aileron Balance RH
1	MC62701-047	Stabilator Trim Aft
2	MC62701-054	Stab Trim Fwd LH and RH (Manual)
1	MC62701-060	Stabilator Trim Fwd LH (Electric)

**PA34-200**  
 S/N 34-7250001 thru 34-7450220  
 Complete Kit P/N PCKT200-01 (Manual Trim)  
 Complete Kit P/N PCKT200-05 (Electric Trim)  
 Stabilator Kit P/N PCKT-STAB-11

Qty	Part Number	Location
2	MC62701-036	Aileron Forward LH and RH
2	MC62701-074	Aileron Wing LH and RH
1	MC62701-076	Aileron Balance LH
1	MC62701-075	Aileron Balance RH
2	MC62701-093	Aileron/Rudder Interconnect Aft
2	MC62701-094	Aileron/Rudder Interconnect Fwd
2	MC62701-081	Rudder Forward
2	MC62701-072	Rudder Aft
2	MC62701-069	Rudder Trim Fwd
1	MC62701-070	Rudder Trim Aft
1	MC62701-078	Stabilator Forward LH
1	MC62701-037	Stabilator Forward RH
1	MC62701-079	Stabilator Aft Upper
1	MC62701-080	Stabilator Aft Lower
2	MC62701-077	Stab Trim Fwd LH and RH (Manual)
1	MC62701-073	Stabilator Trim Aft
1	MC62701-071	Flap
1	MC62701-097	Stab Trim Fwd LH&RH (Autopilot)

**PA34-200**  
 S/N 34-7250001 thru 34-7450024,  
 34-7450025 thru 34-7450220 with  
 Altimatic IIIB Autopilot If Kit 760-776 installed  
 Complete Kit P/N PCKT200-10 (Electric Trim)  
 Stabilator Kit P/N PCKT-STAB-11

Qty	Part Number	Location
2	MC62701-036	Aileron Forward LH and RH
2	MC62701-074	Aileron Wing LH and RH
1	MC62701-076	Aileron Balance LH
1	MC62701-075	Aileron Balance RH
2	MC62701-093	Aileron/Rudder Interconnect Aft
2	MC62701-094	Aileron/Rudder Interconnect Fwd
2	MC62701-081	Rudder Forward
2	MC62701-072	Rudder Aft
2	MC62701-069	Rudder Trim Fwd
1	MC62701-070	Rudder Trim Aft
1	MC62701-078	Stabilator Forward LH
1	MC62701-037	Stabilator Forward RH
1	MC62701-079	Stabilator Aft Upper
1	MC62701-080	Stabilator Aft Lower
1	MC62701-077	Stab Trim Fwd RH
1	MC62701-073	Stabilator Trim Aft
1	MC62701-071	Flap
1	MC62701-097	Stab Trim Fwd LH (Autopilot)
2	MC62701-128	Interconnect

**PA34-200T**  
 S/N 34-7570001 - 34-8170092  
 For aircraft with Altimatic IIIB Autopilot  
 Complete Kit P/N PCKT200T-01 (Manual Trim)  
 Complete Kit P/N PCKT200T-02 (Electric Trim)  
 Stabilator Kit P/N PCKT-STAB-12

Qty	Part Number	Location
2	MC62701-036	Aileron Forward LH and RH
2	MC62701-127	Aileron Wing LH and RH
1	MC62701-125	Aileron Balance LH
1	MC62701-126	Aileron Balance RH
2	MC62701-081	Rudder Forward
1	MC62701-072	Rudder Aft
2	MC62701-069	Rudder Trim Control Forward
1	MC62701-070	Rudder Trim Control Aft
1	MC62701-078	Stabilator Forward LH
1	MC62701-037	Stabilator Forward RH
1	MC62701-129	Stabilator Aft Upper
1	MC62701-080	Stabilator Aft Lower
2	MC62701-077	Stab Trim Fwd LH and RH (Manual)
1	MC62701-073	Stabilator Trim Aft
1	MC62701-071	Flap
1	MC62701-097	Stab Trim Fwd LH (Electric)(Autopilot)

**PA34-220T**  
 S/N 34-8133001 thru 34-8633031,  
 3433001 thru 3433172, 3447001 thru 3449999  
 Complete Kit P/N PCKT220T-01  
 Stabilator Kit P/N PCKT-STAB-12

Qty	Part Number	Location
2	MC62701-228	Aileron Forward LH and RH
2	MC62701-127	Aileron Wing LH and RH
1	MC62701-125	Aileron Balance LH
1	MC62701-126	Aileron Balance RH
2	MC62701-081	Rudder Forward
1	MC62701-072	Rudder Aft
2	MC62701-069	Rudder Trim Control Forward
1	MC62701-070	Rudder Trim Control Aft
1	MC62701-078	Stabilator Forward LH
1	MC62701-037	Stabilator Forward RH
1	MC62701-129	Stabilator Aft Upper
1	MC62701-080	Stabilator Aft Lower
2	MC62701-077	Stab Trim Fwd LH and RH (Manual)
2	MC62701-073	Stabilator Trim Aft
1	MC62701-071	Flap
1	MC62701-097	Stab Trim Fwd LH (Electric)(Autopilot)

**1 Stabilator kits to assist with Piper AD2013-02-13 include cables designated with 1 plus 2 each MS21251-B55 Barrels and 10 each MS21256-1 Locking Clips.**  
**2 Included in kits for manual trim aircraft only.**  
**3 Included in kits for electric trim aircraft only.**  
**4 Kits for electric trim aircraft include only one of this part number.**  
**5 Kits for electric trim aircraft include two of this part number.**

### General Piper Cable Notes: Corrosion Protection

All Piper cables are coated with a modified MIL-PRF-16173 compound. It provides additional corrosion protection beyond the standard MIL-SPEC rust preventive oil. This provides both exceptional wear resistance and corrosion protection for many years.



# Flight Control System

## Flight Control Cables - Beechcraft

Models 19, 23 and 24 Musketeer, Sport, Sundowner  
A23-19, 19A, M19A, B19, 23, A23, A23A, B23, C23,  
A23-24, A24

Part Number	Location
MCNAS30245-2053	Stabilator Tab
MCNAS31424-0870	Stabilator
MCNAS31424-0934	Rudder Aft LH
MCNAS31424-1152	Stabilator
MCNAS31424-1242	Rudder Fwd RH
MCNAS31425-0820	Stabilator
MCNAS31425-0931	Rudder Aft RH
MCNAS31425-1220	Rudder Fwd LH
MCNAS31425-1411	Stabilator/Elevator Fwd
MCNAS31426-1170	Aileron RH
MCNAS31427-1131	Aileron
MCNAS31427-1370	Aileron LH

Model 24 Musketeer, Sierra  
A24R, B24R, C24R

MCNAS30245-2053	Stabilator Tab
MCNAS31424-0870	Stabilator
MCNAS31424-0934	Rudder Aft LH
MCNAS31424-1242	Rudder Fwd RH
MCNAS31424-1340	Stabilator
MCNAS31425-0820	Stabilator
MCNAS31425-0931	Rudder Aft RH
MCNAS31425-1220	Rudder Fwd LH
MCNAS31425-1345	Stabilator
MCNAS31426-1170	Aileron RH
MCNAS31427-1180	Aileron
MCNAS31427-1370	Aileron LH

Model 33 Debonair and Bonanza  
35-33

Qty	Part Number	Location
2	MC33-524000-17	Elevator Fwd
1	MC33-524000-47 <sup>2</sup>	Elevator Tab
1	MC35-524314 <sup>2</sup>	Aileron
2	MC36-521011-1	Aileron Aft
2	MC36-521011-3	Aileron Fwd
1	MC36-524000-29 <sup>2</sup>	Elevator Tab RH
1	MC36-524000-31 <sup>2</sup>	Elevator Tab LH
1	MCNAS30422-0255	Aileron
1	MCNAS30426-0603	Aileron
2	MCNAS30435-0564	Elevator
2	MCNAS30435-1325	Rudder Fwd
2	33-524000-31 <sup>3</sup>	Rudder Aft
1	MCNAS30466-0173	Aileron
2	MCNAS31237-0790	Elevator Tab

Model 33 Debonair and Bonanza  
35-A33

Qty	Part Number	Location
1	MC33-524000-61	Elevator Down
1	MC36-524000-29 <sup>2</sup>	Elevator Tab RH
1	MC36-524000-31 <sup>2</sup>	Elevator Tab LH
1	MCNAS30266-3242	Elevator Tab
2	MCNAS30435-0564	Elevator
2	MCNAS31237-0790	Elevator Tab
1	MCNAS30434-1520	Elevator Up
1	35-524351-2 <sup>4</sup>	Indicator Actuating
2	MCNAS30435-1325	Rudder Fwd
2	33-524000-31 <sup>3</sup>	Rudder Aft
1	MC35-524314 <sup>2</sup>	Aileron
2	MC36-521011-1	Aileron Aft
2	MC36-521011-3	Aileron Fwd
1	MCNAS30422-0255	Aileron
1	MCNAS30426-0603	Aileron
1	MCNAS30466-0173	Aileron
2	35-815109 <sup>3</sup>	Landing Gear Up Lock

Model 33 Debonair and Bonanza  
35-B33, 35-C33, 35-C33A, E33

Qty	Part Number	Location
1	MC33-524000-61	Elevator Down
1	MC33-524001-1 <sup>2</sup>	Elevator Tab
1	MC36-524000-29 <sup>2</sup>	Elevator Tab RH
1	MC36-524000-31 <sup>2</sup>	Elevator Tab LH
1	MCNAS30434-1520	Elevator Up
2	MCNAS30435-0564	Elevator
2	MCNAS31237-0790	Elevator Tab
1	35-524647-9 <sup>4</sup>	Indicator Actuating
2	MCNAS30435-1325	Rudder Fwd
2	33-524000-31 <sup>3</sup>	Rudder Aft
1	MC35-524314 <sup>2</sup>	Aileron
2	MC36-521011-1	Aileron Aft
2	MC36-521011-3	Aileron Fwd
1	MCNAS30422-0255	Aileron
1	MCNAS30426-0603	Aileron
1	MCNAS30466-0173	Aileron
2	35-815109 <sup>3</sup>	Landing Gear Up Lock

Model 33 Debonair and Bonanza

35-C33A, E33A, F33, F33A, G33  
S/N CE-028 thru CE-315, CD-1235 thru CD-1304  
Complete Kit P/N BCKT33-04

Qty	Part Number	Location
1	MC33-524000-61	Elevator Down
1	MC36-524000-29 <sup>2</sup>	Elevator Tab RH
1	MC36-524000-31 <sup>2</sup>	Elevator Tab LH
1	MCNAS30434-1520	Elevator Up
2	MCNAS30435-0564	Elevator
2	MCNAS31237-0790	Elevator Tab
1	33-524001-7 <sup>4</sup>	Elevator Tab
1	35-524647-9 <sup>4</sup>	Indicator Actuating
2	MCNAS30435-1325	Rudder Fwd
2	33-524000-31 <sup>3</sup>	Rudder Aft
1	MC35-524314 <sup>2</sup>	Aileron
2	MC36-521011-1	Aileron Aft
2	MC36-521011-3	Aileron Fwd
1	MCNAS30422-0255	Aileron
1	MCNAS30426-0603	Aileron
1	MCNAS30466-0173	Aileron
2	35-815109 <sup>3</sup>	Landing Gear Up Lock

Model 33 Debonair and Bonanza  
E33C

S/N CJ-001 thru CJ-025  
Complete Kit P/N BCKT33-13

Qty	Part Number	Location
1	MC33-524000-61	Elevator Down
1	MC36-524000-29 <sup>2</sup>	Elevator Tab RH
1	MC36-524000-31 <sup>2</sup>	Elevator Tab LH
1	MCNAS30434-1520	Elevator Up
2	MCNAS30435-0564	Elevator
2	MCNAS31237-0790	Elevator
1	33-524001-7 <sup>4</sup>	Elevator Tab Control
1	35-524647-9 <sup>4</sup>	Indicator Actuating
2	NAS30435-1325 <sup>4</sup>	Rudder Fwd
2	35-524000-67 <sup>4</sup>	Rudder Aft
1	MC35-524314 <sup>2</sup>	Aileron
2	MC36-521011-1	Aileron Aft
2	MC36-521011-3	Aileron Fwd
1	MCNAS30422-0255	Aileron
1	MCNAS30426-0603	Aileron
1	MCNAS30466-0173	Aileron
2	35-815109 <sup>3</sup>	Landing Gear Up Lock

Model 33 Debonair and Bonanza  
F33A

S/N CE-316 thru CE-510  
Complete Kit P/N BCKT33-05

Qty	Part Number	Location
1	MC33-524028	Elevator Down
1	MC33-524029	Elevator Down
1	MC36-524000-29 <sup>2</sup>	Elevator Tab RH
1	MC36-524000-31 <sup>2</sup>	Elevator Tab LH
1	MCNAS30434-1520	Elevator Up
2	MCNAS30435-0564	Elevator
2	MCNAS31237-0534	Elevator Tab
1	35-524647-9 <sup>4</sup>	Indicator Actuating
2	MCNAS30435-1321	Rudder Fwd
2	33-524000-31 <sup>3</sup>	Rudder Aft
1	MC35-524314 <sup>2</sup>	Aileron
2	MC36-521011-1	Aileron Aft
2	MC36-521011-3	Aileron Fwd
1	MCNAS30422-0255	Aileron
1	MCNAS30426-0603	Aileron
1	MCNAS30466-0173	Aileron
2	35-815109 <sup>3</sup>	Landing Gear Up Lock

Model 33 Debonair and Bonanza  
F33A

S/N CE-511 thru CE-677  
Complete Kit P/N BCKT33-06

Qty	Part Number	Location
1	MC33-524029	Elevator Down
1	MC36-524000-29 <sup>2</sup>	Elevator Tab RH
1	MC36-524000-31 <sup>2</sup>	Elevator Tab LH
1	MCNAS30434-1520	Elevator Up
2	MCNAS30435-0564	Elevator
1	MCNAS31237-0284	Elevator Tab
1	MCNAS31237-0520	Elevator Tab
1	002-524028-3 <sup>2</sup>	Elevator Tab
1	35-524647-9 <sup>4</sup>	Indicator Actuating
1	MC002-524000-23	Rudder
1	NAS304-35-1594 <sup>4</sup>	Rudder
1	NAS304-35-1600 <sup>4</sup>	Rudder
1	MC35-524314 <sup>2</sup>	Aileron
2	MC36-521011-1	Aileron Aft
2	MC36-521011-3	Aileron Fwd
1	MCNAS30422-0255	Aileron
1	MCNAS30426-0603	Aileron
1	MCNAS30466-0173	Aileron
2	35-815109 <sup>3</sup>	Landing Gear Up Lock

Model 33 Debonair and Bonanza

F33A  
S/N CE-678 thru CE-680  
Complete Kit P/N BCKT33-07

Qty	Part Number	Location
1	MC002-524028-23 <sup>2</sup>	Elevator Tab
1	MC33-524029	Elevator Down
1	MC36-524000-29 <sup>2</sup>	Elevator Tab RH
1	MC36-524000-31 <sup>2</sup>	Elevator Tab LH
1	MCNAS30434-1520	Elevator Up
2	MCNAS30435-0564	Elevator
1	MCNAS31237-0204	Elevator Tab
1	MCNAS31237-0520	Elevator Tab
1	35-524647-9 <sup>4</sup>	Indicator Actuating
2	MC002-524000-23	Rudder
1	NAS304-35-1594 <sup>4</sup>	Rudder
1	NAS304-35-1600 <sup>4</sup>	Rudder
1	MC35-524314 <sup>2</sup>	Aileron
2	MC36-521011-1	Aileron Aft
2	MC36-521011-3	Aileron Fwd
1	MCNAS30422-0255	Aileron
1	MCNAS30426-0603	Aileron
1	MCNAS30466-0173	Aileron
2	35-815109 <sup>3</sup>	Landing Gear Up Lock

Model 33 Debonair and Bonanza  
F33A

S/N CE-681 thru CE-999  
Complete Kit P/N BCKT33-08

Qty	Part Number	Location
1	MC002-524028-23 <sup>2</sup>	Elevator Tab
1	MC33-524029	Elevator Down
1	MC36-524000-29 <sup>2</sup>	Elevator Tab RH
1	MC36-524000-31 <sup>2</sup>	Elevator Tab LH
1	MCNAS30434-1520	Elevator Up
2	MCNAS30435-0564	Elevator
1	MCNAS31237-0204	Elevator Tab
1	MCNAS31237-0520	Elevator Tab
1	35-524647-9 <sup>4</sup>	Indicator Actuating
2	MC002-524000-23	Rudder
1	NAS304-35-1594 <sup>4</sup>	Rudder
1	NAS304-35-1600 <sup>4</sup>	Rudder
1	MC35-524314-2 <sup>2</sup>	Aileron Fuselage
1	MCNAS30422-0255	Aileron
1	NAS304-26-0964 <sup>4</sup>	Aileron
1	NAS304-66-1035 <sup>4</sup>	Aileron
2	MCNAS30537-0647	Aileron Aft
2	MCNAS30537-0667	Aileron Fwd
2	35-815109 <sup>3</sup>	Landing Gear Up Lock

Model 33 Debonair and Bonanza  
F33C

S/N CJ-026 thru CJ-128  
Complete Kit P/N BCKT33-09

Qty	Part Number	Location
1	MC33-524000-61	Elevator Down
1	MC36-524000-29 <sup>2</sup>	Elevator Tab RH
1	MC36-524000-31 <sup>2</sup>	Elevator Tab LH
1	MCNAS30434-1520	Elevator Up
2	MCNAS30435-0564	Elevator
2	MCNAS31237-0790	Elevator
1	33-524001-7 <sup>4</sup>	Elevator Tab Control
1	35-524647-9 <sup>4</sup>	Indicator Actuating
2	MCNAS30435-1325	Rudder Fwd
2	33-524000-67 <sup>4</sup>	Rudder Aft
1	MC35-524314 <sup>2</sup>	Aileron
1	MCNAS30422-0255	Aileron
2	MC36-521011-1	Aileron Aft
2	MC36-521011-3	Aileron Fwd
1	MCNAS30426-0603	Aileron
1	MCNAS30466-0173	Aileron
2	35-815109 <sup>3</sup>	Landing Gear Up Lock

Model 33 Debonair and Bonanza  
F33C

S/N CJ-129 thru CJ-999  
Complete Kit P/N BCKT33-10

Qty	Part Number	Location
1	MC33-524000-61	Elevator Down
1	MC36-524000-29 <sup>2</sup>	Elevator Tab RH
1	MC36-524000-31 <sup>2</sup>	Elevator Tab LH
1	MCNAS30434-1520	Elevator Up
2	MCNAS30435-0564	Elevator
2	MCNAS31237-0790	Elevator
1	33-524001-7 <sup>4</sup>	Elevator Tab Control
1	35-524647-9 <sup>4</sup>	Indicator Actuating
2	MCNAS30435-1325	Rudder Fwd
2	33-524000-67 <sup>4</sup>	Rudder Aft
1	MC35-524314-2 <sup>2</sup>	Aileron Fuselage
1	MCNAS30422-0255	Aileron
2	MCNAS30537-0647	Aileron Aft
2	MCNAS30537-0667	Aileron Fwd
1	NAS304-26-0964 <sup>4</sup>	Aileron
1	NAS304-66-1035 <sup>4</sup>	Aileron
2	35-815109 <sup>3</sup>	Landing Gear Up Lock

<sup>1</sup> Partial model eligibility  
<sup>2</sup> Cable/Chain assembly  
<sup>3</sup> Pending FAA-PMA approval  
<sup>4</sup> Not available from McFarlane



### FAA-PMA Approved

Model 35 Bonanza  
S/N D-0001 thru D-0014

Complete Kit P/N BCKT35-15		
Qty	Part Number	Location
1	MC35-524004	Elevator Fwd
4	MCNAS30227-0590	Tab Actuating
1	MCNAS30266-3636	Elevator Trim Tab Fwd
1	MCNAS30425-0082	Elevator Aft
1	MCNAS30436-0197	Elevator Aft
1	35-524030	Tab Drum
1	35-524294	Bungee
1	35-524531-2	Indicator Actuating
1	MCNAS30425-0100	Rudder Aft RH
1	MCNAS30425-0106	Rudder Aft LH
1	MCNAS30433-0255	Rudder Aft
2	MCNAS31414-1875	Rudder FWD
1	MCNAS30422-0256	Aileron Fwd LH
1	MCNAS30424-0397	Aileron Center LH
1	MCNAS305-24-0514	Aileron Lower RH
1	MCNAS305-25-0546	Aileron, Upper RH
1	MCNAS305-34-0514	Aileron, Lower LH
2	MCNAS305-34-0640	Cable
1	MCNAS305-35-0546	Aileron, Upper LH
2	MCNAS305-35-0672	Cable
1	MCNAS31415-0152	Aileron Aft LH
1	MCNAS31415-0472	Aileron Aft RH
1	35-524174	Cable Assy, Fwd Aileron

Model 35 Bonanza  
S/N D-0015 thru D-1500

Complete Kit P/N BCKT35-01		
Qty	Part Number	Location
1	MC35-524004	Elevator Fwd
4	MCNAS30227-0590	Tab Actuating
1	MCNAS30266-3500	Elevator Trim Tab Fwd
1	MCNAS30425-0082	Elevator Aft
1	MCNAS30436-0197	Elevator Aft
1	35-524030	Tab Drum
1	35-524294	Bungee
1	35-524531-2	Indicator Actuating
1	MCNAS30425-0100	Rudder Aft RH
1	MCNAS30425-0106	Rudder Aft LH
1	MCNAS30433-0255	Rudder Aft
2	MCNAS31414-1875	Rudder FWD
1	MCNAS30422-0256	Aileron Fwd LH
1	MCNAS30424-0397	Aileron Center LH
1	MCNAS305-24-0514	Aileron Lower RH
1	MCNAS305-25-0546	Aileron, Upper RH
1	MCNAS305-34-0514	Aileron, Lower LH
2	MCNAS305-34-0640	Cable
1	MCNAS305-35-0546	Aileron, Upper LH
2	MCNAS305-35-0672	Cable
1	MCNAS31415-0152	Aileron Aft LH
1	MCNAS31415-0472	Aileron Aft RH
1	35-524174	Cable Assy, Fwd Aileron

Model 35 Bonanza  
A35, B35  
S/N D-1501 thru D-2680

Complete Kit P/N BCKT35-02		
Qty	Part Number	Location
4	MCNAS30227-0590	Tab Actuating
1	MCNAS30266-3500	Elevator Trim Tab Fwd
1	MCNAS30425-0082	Elevator Aft
1	MCNAS30436-0197	Elevator Aft
1	MC35-524004	Elevator Fwd
1	35-524030	Tab Drum
1	35-524294	Cable Assy, Bungee
1	35-524531-2	Indicator Actuating
1	MCNAS30425-0100	Rudder Aft RH
1	MCNAS30425-0106	Rudder Aft LH
1	MCNAS30433-0255	Rudder Aft
2	MCNAS31414-1871	Rudder Fwd
1	MCNAS30422-0256	Aileron Fwd LH
1	MCNAS30424-0610	Aileron Center RH
1	MCNAS30426-0603	Aileron
1	MCNAS30466-0170	Aileron Center
2	MC35-521188	Aileron
2	MC35-521189	Aileron
1	MC35-524314	Cable/Chain, Aileron

Model 35 Bonanza  
C35, D35, E35, F35, G35  
S/N D-2681 thru D-4865

Complete Kit P/N BCKT35-03		
Qty	Part Number	Location
4	MCNAS30327-0590	Tab Actuating
1	MCNAS30266-3500	Elevator Trim Tab Fwd
1	MCNAS30266-3636	Elevator Trim Tab Fwd
1	MCNAS30425-0082	Elevator Aft
1	MCNAS30436-0197	Elevator Aft
1	MC35-524385	Elevator Fwd
1	35-524030	Tab Drum
1	35-524383-4	Cable Assy, Bungee

Kit continues in next column

Continued from previous column

Model 35 Bonanza  
C35, D35, E35, F35, G35  
S/N D-2681 thru D-4865

Complete Kit P/N BCKT35-03		
Qty	Part Number	Location
1	35-524531-2	Indicator Actuating
1	MCNAS30425-0100	Rudder Aft RH
1	MCNAS30425-0106	Rudder Aft LH
1	MCNAS30433-0255	Rudder Aft
2	MCNAS31414-1871	Rudder Fwd
1	MCNAS30422-0256	Aileron Fwd LH
1	MCNAS30424-0610	Aileron Center RH
1	MCNAS30426-0603	Aileron
1	MCNAS30466-0170	Aileron Center
2	MC35-521188	Aileron
2	MC35-521189	Aileron
1	MC35-524314	Cable/Chain, Aileron

Model 35 Bonanza  
H35, J35  
S/N D-4866 thru D-5725

Complete Kit P/N BCKT35-04		
Qty	Part Number	Location
1	MCNAS30266-3506	Elevator Trim Tab
1	MCNAS30327-0581	Elevator Trim
1	MCNAS30327-0587	Elevator Trim
1	MCNAS30327-0597	Elevator Trim
1	MCNAS30327-0605	Elevator Trim
1	MCNAS30425-0082	Elevator Aft
1	MCNAS30436-0197	Elevator Aft
1	MC35-524382	Elevator Tab Aft
1	MC35-524385	Elevator Fwd
1	35-524030	Tab Drum
1	35-524383-4	Cable Assy, Bungee
1	35-524531-2	Indicator Actuating
1	MCNAS30425-0100	Rudder Aft RH
1	MCNAS30425-0106	Rudder Aft LH
1	MCNAS30433-0255	Rudder Aft
2	MCNAS31414-1871	Rudder Fwd
1	MCNAS30422-0255	Aileron
1	MCNAS30426-0603	Aileron
1	MCNAS30466-0173	Aileron
2	MC36-521011-1	Aileron
2	MC36-521011-3	Aileron
1	MC35-524314	Cable/Chain, Aileron

Model 35 Bonanza  
K35  
S/N D-5726 thru D-5727, D-5729 thru D-5747

Complete Kit P/N BCKT35-05		
Qty	Part Number	Location
1	MCNAS30266-3506	Elevator Trim Tab
1	MCNAS30327-0581	Elevator Trim
1	MCNAS30327-0587	Elevator Trim
1	MCNAS30327-0597	Elevator Trim
1	MCNAS30327-0605	Elevator Trim
1	MCNAS30425-0082	Elevator Aft
1	MCNAS30436-0197	Elevator Aft
1	MC35-524382	Elevator Tab Aft
1	MC35-524385	Elevator Fwd
1	35-524030	Tab Drum
1	35-524383-4	Cable Assy, Bungee
1	35-524531-2	Indicator Actuating
2	MCNAS30425-0106	Rudder Aft LH and RH
1	MCNAS30433-0247	Rudder Aft
2	MCNAS31514-1871	Rudder Fwd
1	MCNAS30422-0255	Aileron
1	MCNAS30426-0603	Aileron
1	MCNAS30466-0173	Aileron
2	MC36-521011-1	Aileron
2	MC36-521011-3	Aileron
1	MC35-524314	Cable/Chain, Aileron

Model 35 Bonanza  
K35, M35  
S/N D-5728, D-5748 thru D-6561

Complete Kit P/N BCKT35-06		
Qty	Part Number	Location
1	MCNAS30266-3506	Elevator Trim Tab
1	MCNAS30327-0581	Elevator Trim
1	MCNAS30327-0587	Elevator Trim
1	MCNAS30327-0597	Elevator Trim
1	MCNAS30327-0605	Elevator Trim
1	MCNAS30425-0082	Elevator Aft
1	MCNAS30436-0197	Elevator Aft
1	MC35-524382	Elevator Tab Aft
1	35-524030	Tab Drum
1	35-524383-4	Cable Assy, Bungee
1	35-524385-4	Elevator Control Fwd
1	35-524531-2	Indicator Actuating
2	MCNAS30425-0106	Rudder Aft LH and RH
1	MCNAS30433-0247	Rudder Aft

Kit continues in next column

Continued from previous column

Model 35 Bonanza  
K35, M35  
S/N D-5728, D-5748 thru D-6561

Complete Kit P/N BCKT35-06		
Qty	Part Number	Location
2	MCNAS31514-1871	Rudder Fwd
1	MCNAS30422-0255	Aileron
1	MCNAS30426-0603	Aileron
1	MCNAS30466-0173	Aileron
2	MC36-521011-1	Aileron
2	MC36-521011-3	Aileron
1	MC35-524314	Cable/Chain, Aileron

Model 35 Bonanza  
N35  
S/N D-6562 thru D-6841

Complete Kit P/N BCKT35-07		
Qty	Part Number	Location
1	MCNAS30266-3506	Elevator Trim Tab
1	MCNAS30327-0581	Elevator Trim
1	MCNAS30327-0587	Elevator Trim
1	MCNAS30327-0597	Elevator Trim
1	MCNAS30327-0605	Elevator Trim
1	MCNAS30425-0082	Elevator Aft
1	MCNAS30435-2087	Elevator
1	MCNAS30436-0197	Elevator Aft
1	MC35-524382	Elevator Tab Aft
1	35-524000-3	Elevator
1	35-524030	Tab Drum
1	35-524383-4	Cable Assy, Bungee
1	35-524531-2	Indicator Actuating
2	MCNAS30425-0106	Rudder Aft LH and RH
1	MCNAS30433-0247	Rudder Aft
2	MCNAS31514-1871	Rudder Fwd
1	MCNAS30422-0255	Aileron
1	MCNAS30426-0603	Aileron
1	MCNAS30466-0173	Aileron
2	MC36-521011-1	Aileron
2	MC36-521011-3	Aileron
1	MC35-524314	Cable/Chain, Aileron

Model 35 Bonanza  
P35  
S/N D-6842 thru D-7309, except D-7140

Complete Kit P/N BCKT35-09		
Qty	Part Number	Location
1	MCNAS30266-3506	Elevator Trim Tab
1	MCNAS30327-0581	Elevator Trim
1	MCNAS30327-0587	Elevator Trim
1	MCNAS30327-0597	Elevator Trim
1	MCNAS30327-0605	Elevator Trim
1	MCNAS30425-0082	Elevator Aft
1	MCNAS30435-2087	Elevator
1	MCNAS30436-0197	Elevator Aft
1	MC35-524382	Elevator Tab Aft
1	MC35-524651-1	Elevator
1	35-524030	Tab Drum
1	35-524383-4	Cable Assy, Bungee
1	35-524647-9	Indicator Actuating
2	MCNAS30425-0106	Rudder Aft LH and RH
1	MCNAS30433-0247	Rudder Aft
2	MCNAS31514-1871	Rudder Fwd
1	MCNAS30422-0255	Aileron
1	MCNAS30426-0603	Aileron
1	MCNAS30466-0173	Aileron
2	MC36-521011-1	Aileron
2	MC36-521011-3	Aileron
1	MC35-524314	Cable/Chain, Aileron

Model 35 Bonanza  
S35, V35, V35TC, V35A, & V35ATC  
S/N D-7140 and D-7310 thru D-8840

Complete Kit P/N BCKT35-10		
Qty	Part Number	Location
1	MCNAS30266-3950	Elevator Trim
1	MCNAS30327-0581	Elevator Trim
1	MCNAS30327-0587	Elevator Trim
1	MCNAS30327-0597	Elevator Trim
1	MCNAS30327-0605	Elevator Trim
1	MCNAS30425-0082	Elevator Aft
1	MCNAS30435-2087	Elevator
1	MCNAS30436-0197	Elevator Aft
1	MC1781-2	Elevator Trim
1	MC35-524382	Elevator Tab Aft
1	MC35-524651-1	Elevator
1	35-524383-4	Cable Assy, Bungee
1	35-524647-9	Indicator Actuating
2	MCNAS30425-0106	Rudder Aft LH and RH
2	MCNAS31514-1871	Rudder Fwd

Kit continues on next page

1 Partial model eligibility  
2 Cable/Chain assembly  
3 Pending FAA-PMA approval  
4 Not available from McFarlane

# Flight Control System

## Flight Control Cables - Beechcraft

Continued from previous page  
Model 35 Bonanza  
S35, V35, V35TC, V35A, & V35ATC  
S/N D-7140 and D-7310 thru D-8840  
Complete Kit P/N BCKT35-10

Qty	Part Number	Location
1	MCNAS30433-0247	Rudder Aft
1	MCNAS30422-0255	Aileron
1	MCNAS30426-0603	Aileron
1	MCNAS30466-0173	Aileron
2	MC36-521011-1	Aileron
2	MC36-521011-3	Aileron
1	MC35-524314 <sup>2</sup>	Cable/Chain, Aileron

Model 35 Bonanza  
V35A, V35A-TC  
S/N D-8841 thru D-9068 without Electric Trim  
Complete Kit P/N BCKT35-16

Qty	Part Number	Location
1	MCNAS30266-3950	Elevator Trim
1	MCNAS30327-0581	Elevator Trim
1	MCNAS30327-0587	Elevator Trim
1	MCNAS30327-0597	Elevator Trim
1	MCNAS30327-0605	Elevator Trim
1	MCNAS30425-0082	Elevator Aft
1	MCNAS30435-2087	Elevator
1	MCNAS30436-0197	Elevator Aft
1	MC1781-2	Elevator Trim
1	MC35-524382	Elevator Tab Aft
1	35-524670 <sup>2</sup>	Elevator Trim Tab
1	MC35-524651-1	Elevator
1	35-524383-4 <sup>3</sup>	Cable Assy, Bungee
1	35-524647-9 <sup>4</sup>	Indicator Actuating
2	MCNAS30425-0106	Rudder Aft LH & RH
1	MCNAS30433-0247	Rudder Aft
2	MCNAS31514-1871	Rudder Fwd
1	MCNAS30422-0255	Aileron
1	MCNAS30426-0603	Aileron
1	MCNAS30466-0173	Aileron
2	MC36-521011-1	Aileron
2	MC36-521011-3	Aileron
1	MC35-524314 <sup>2</sup>	Cable/Chain, Aileron

Model 35 Bonanza  
S35, V35, V35TC, V35A, & V35ATC  
S/N D-8841 thru D-9068 with Electric Trim  
Complete Kit P/N BCKT35-12

Qty	Part Number	Location
1	MCNAS30266-3950	Elevator Trim
1	MCNAS30327-0581	Elevator Trim
1	MCNAS30327-0587	Elevator Trim
1	MCNAS30327-0597	Elevator Trim
1	MCNAS30327-0605	Elevator Trim
1	MCNAS30425-0082	Elevator Aft
1	MCNAS30435-2087	Elevator
1	MCNAS30436-0197	Elevator Aft
1	MC35-524382	Elevator Tab Aft
1	MC35-524651-1	Elevator
1	35-524383-4 <sup>3</sup>	Cable Assy, Bungee
1	35-524647-9 <sup>4</sup>	Elevator Trim Tab
1	35-524647-9 <sup>4</sup>	Indicator Actuating
2	MCNAS30425-0106	Rudder Aft LH and RH
2	MCNAS31514-1871	Rudder Fwd
1	MCNAS30433-0247	Rudder Aft
1	MCNAS30422-0255	Aileron
1	MCNAS30426-0603	Aileron
1	MCNAS30466-0173	Aileron
2	MC36-521011-1	Aileron
2	MC36-521011-3	Aileron
1	MC35-524314 <sup>2</sup>	Cable/Chain, Aileron

Model 35 Bonanza  
V35B, & V35BTC  
S/N D-9069 thru D-10119 with Electric Trim  
Complete Kit P/N BCKT35-11

Qty	Part Number	Location
1	MCNAS30266-3954	Elevator Trim
1	MCNAS30327-0581	Elevator Trim
1	MCNAS30327-0587	Elevator Trim
1	MCNAS30327-0597	Elevator Trim
1	MCNAS30327-0605	Elevator Trim
1	MCNAS30425-0082	Elevator Aft
1	MCNAS30435-2087	Elevator
1	MCNAS30436-0197	Elevator Aft
1	MC35-524382	Elevator Tab Aft
1	35-524670 <sup>2</sup>	Elevator Trim Tab
1	MC35-524651-1	Elevator
1	35-524383-4 <sup>3</sup>	Cable Assy, Bungee
1	35-524647-9 <sup>4</sup>	Indicator Actuating
2	MCNAS30425-0106	Rudder Aft LH & RH
1	MCNAS30433-0247	Rudder Aft
2	MCNAS31514-1871	Rudder Fwd
1	MCNAS30422-0255	Aileron
1	MCNAS30426-0603	Aileron
1	MCNAS30466-0173	Aileron
2	MC36-521011-1	Aileron

Kit continues in next column  
www.mcfarlaneaviation.com

Continued from previous column  
Model 35 Bonanza  
V35B, & V35BTC  
S/N D-9069 thru D-99999 with Electric Trim  
Complete Kit P/N BCKT35-11

Qty	Part Number	Location
2	MC36-521011-3	Aileron
1	MC35-524314 <sup>2</sup>	Cable/Chain, Aileron

Model 35 Bonanza  
V35B, V35B-TC  
S/N D-9069 thru D-99999 without Electric Trim  
Complete Kit P/N BCKT35-17

Qty	Part Number	Location
1	MCNAS30266-3954	Elevator Trim
1	MCNAS30277-1156	Elevator Trim
1	MCNAS30327-0581	Elevator Trim
1	MCNAS30327-0587	Elevator Trim
1	MCNAS30327-0597	Elevator Trim
1	MCNAS30327-0605	Elevator Trim
1	MCNAS30425-0082	Elevator Aft
1	MCNAS30435-2087	Elevator
1	MCNAS30436-0197	Elevator Aft
1	MC35-524382	Elevator Tab Aft
1	35-524670 <sup>2</sup>	Elevator Trim Tab
1	MC35-524651-1	Elevator
1	35-524383-4 <sup>3</sup>	Cable Assy, Bungee
1	35-524647-9 <sup>4</sup>	Indicator Actuating
2	MCNAS30425-0106	Rudder Aft LH & RH
1	MCNAS30433-0247	Rudder Aft
2	MCNAS31514-1871	Rudder Fwd
1	MCNAS30422-0255	Aileron
1	MCNAS30426-0603	Aileron
1	MCNAS30466-0173	Aileron
2	MC36-521011-1	Aileron
2	MC36-521011-3	Aileron
1	MC35-524314 <sup>2</sup>	Cable/Chain, Aileron

Model 36 Bonanza  
A36  
S/N E-185 thru E-301  
Complete Kit P/N BCKTA36-01

Qty	Part Number	Location
1	MCNAS30434-1624	Elevator Up
2	MCNAS30435-0564	Elevator
2	MCNAS31237-0534	Elevator Tab
1	MC36-524000-23	Elevator Fwd
1	MC36-524000-29 <sup>2</sup>	Cable/Chain, Elev. Tab RH
1	MC36-524000-31 <sup>2</sup>	Cable/Chain, Elev. Tab LH
1	MC36-524000-41	Cable/Chain, Elev.
1	36-524647-9 <sup>4</sup>	Indicator Actuating
2	MCNAS30435-1425	Rudder Fwd
2	MC36-524000-33	Rudder Aft LH & RH
1	MCNAS30422-0255	Aileron
1	MCNAS30426-0703	Aileron LH
1	MCNAS30466-0173	Aileron
2	MC36-521011-1	Aileron
2	MC36-521011-3	Aileron
1	36-524000-19 <sup>4</sup>	Chain Assy Single Cntr Wheel

Model 36 Bonanza  
A36  
S/N E-302 thru E-571  
Complete Kit P/N BCKTA36-02

Qty	Part Number	Location
2	MCNAS30435-0564	Elevator
2	MCNAS31237-0534	Elevator Tab
1	MCNAS30434-1624	Elevator Up
1	MC36-524000-23	Elevator Fwd
1	MC36-524000-41	Cable/Chain, Elevator
1	MC36-524000-31 <sup>2</sup>	Cable/Chain, Elevator Tab LH
1	MC36-524000-29 <sup>2</sup>	Cable/Chain, Elevator Tab RH
1	36-524647-9 <sup>4</sup>	Indicator Actuating
2	MCNAS30435-1421	Rudder Fwd
2	MC36-524000-33	Rudder Aft LH & RH
1	MCNAS30422-0255	Aileron
1	MCNAS30426-0703	Aileron LH
1	MCNAS30466-0173	Aileron
2	MC36-521011-1	Aileron
2	MC36-521011-3	Aileron
1	36-524000-19 <sup>4</sup>	Cable/Chain, Aileron Fuslg.

Model 36 Bonanza  
A36  
S/N E-572 thru E-925  
Complete Kit P/N BCKTA36-03

Qty	Part Number	Location
1	MCNAS30434-1624	Elevator Up
2	MCNAS30435-0564	Elevator
1	MCNAS31237-0284	Elevator Tab
1	MCNAS31237-0520	Elevator Tab

Kit continues in next column

Continued from previous column  
Model 36 Bonanza  
A36  
S/N E-572 thru E-925  
Complete Kit P/N BCKTA36-03

Qty	Part Number	Location
1	MC36-524000-23	Elevator Fwd
1	MC36-524000-29 <sup>2</sup>	Cable/Chain Elev. Tab RH
1	MC36-524000-31 <sup>2</sup>	Cable/Chain, Elev. Tab LH
1	002-524028-9 <sup>4</sup>	Elevator Tab
1	002-524028-1 <sup>4</sup>	Cable Assy, Elev. Control
1	35-524647-9 <sup>4</sup>	Indicator Actuating
1	MCNAS30435-1703	Rudder Fwd LH
1	MCNAS30435-1696	Rudder Fwd RH
2	MC002-524000-23	Rudder Control Aft
2	NAS30537-0667 <sup>4</sup>	Aileron
2	NAS30537-0647 <sup>4</sup>	Aileron
1	MCNAS30422-0255	Aileron
1	MCNAS30426-0703	Aileron LH
1	MCNAS30466-0173	Aileron
1	36-524000-19 <sup>4</sup>	Cable/Chain, Aileron Fuslg.

Model 36 Bonanza  
A36  
S/N E-926 thru E-937  
Complete Kit P/N BCKTA36-04

Qty	Part Number	Location
1	MCNAS30434-1624	Elevator Up
2	MCNAS30435-0564	Elevator
1	MCNAS31237-0284	Elevator Tab
1	MCNAS31237-0520	Elevator Tab
1	MC36-524000-23	Elevator Fwd
1	MC36-524000-29 <sup>2</sup>	Cable/Chain, Elev. Tab RH
1	MC36-524000-31 <sup>2</sup>	Cable/Chain, Elev. Tab LH
1	002-524028-9 <sup>4</sup>	Elevator Tab
1	MC45-526011-7	Chain
1	35-524647-9 <sup>4</sup>	Indicator Actuating
1	002-524028-1 <sup>4</sup>	Cable Assy, Elev. Control
1	MCNAS30435-1703	Rudder Fwd LH
1	MCNAS30435-1696	Rudder Fwd RH
2	MC002-524000-23	Rudder Control Aft
1	MCNAS30566-1035	Aileron
2	MCNAS30537-0647	Aileron
1	MCNAS30422-0255	Aileron Aft
2	MCNAS30537-0667	Aileron Fwd
1	MCNAS30426-1064	Aileron LH
1	MC35-524314-12	Cable/Chain, Aileron Fuslg.

Model 36 Bonanza  
A36  
S/N E-938 thru E14945, E-1947 thru E-2103,  
E-2105 thru E-2110  
Complete Kit P/N BCKTA36-05

Qty	Part Number	Location
1	MC002-524028-9	Cable, Elevator Tab
1	MC002-524028-21	Cable/Chain, Elev. Tab
1	MC36-524000-23	Elevator Fwd
1	MC36-524000-29 <sup>2</sup>	Cable/Chain, Elev. Tab RH
1	MC36-524000-31 <sup>2</sup>	Cable/Chain, Elev. Tab LH
1	MCNAS30434-1624	Elevator Up
2	MCNAS30435-0564	Elevator
1	MCNAS31237-0204	Elevator Tab
1	MCNAS31237-0520	Elevator Tab
1	35-524647-9 <sup>4</sup>	Indicator Actuating
1	MCNAS30435-1696	Rudder Fwd RH
2	MC002-524000-23	Rudder Aft
1	MCNAS30435-1703	Rudder Fwd LH
1	MC35-524314-12	Cable/Chain, Aileron Fuslg.
1	MCNAS30422-0255	Aileron
1	MCNAS30426-1064	Aileron LH
2	MCNAS30537-0647	Aileron Aft
1	MCNAS30537-0667	Aileron Fwd
1	MCNAS30566-1035	Aileron

Model 36 Bonanza  
A36  
S/N E-1946, E-2104, E-2111 thru E-3629,  
E-3631 thru E-3635  
Complete Kit P/N BCKTA36-06

Qty	Part Number	Location
1	MC106-524020-57	Cable/Chain, Elevator Tab
1	MC106-524046-7	Elevator Tab Nose Down
1	MC106-524046-9	Elevator Tab Nose Up
1	MC106-524049-1	Elevator Up Fwd
1	MC106-524049-9	Elevator Down Fwd
1	MC106-524050-1	Elevator Up Aft
1	MC106-524050-3	Elevator Down Aft
1	MC36-524000-63	Cable/Chain, Elev. Tab RH
1	MC36-524000-69	Cable/Chain, Elev. Tab LH
1	MC106-524051-5	Rudder RH
1	MC106-524051-7	Rudder LH
1	MC36-524079-5	Rudder Aft RH

Kit continues on next page

<sup>1</sup> Partial model eligibility  
<sup>2</sup> Cable/Chain assembly  
<sup>3</sup> Pending FAA-PMA approval  
<sup>4</sup> Not available from McFarlane



**FAA-PMA Approved**

Continued from previous page  
**Model 36 Bonanza**  
 A36  
 S/N E-1946, E-2104, E-2111 thru E-3629,  
 E-3631 thru E-3635

Complete Kit P/N BCKTA36-06

Qty	Part Number	Location
1	MC36-524079-7	Rudder Aft LH
1	MC106-524019-47	Cable/Chain, Aileron Tab
1	MC106-524044-19	Aileron
1	MC106-524044-21	Aileron
1	MC106-524044-3	Aileron
1	MC106-524045-5	Aileron
1	MC106-524031-1	Cable/Chain Aileron Tab
1	MC106-524043-11	Aileron Aft LH
1	MC106-524043-5	Aileron Aft RH
2	MC106-524043-7	Aileron Fwd LH & RH

**Model 36 Bonanza**  
 A36TC, B36TC  
 S/N EA-001 thru EA-319 & EA-321 thru EA-388

Complete Kit P/N BCKT36TC-01

Qty	Part Number	Location
1	MC002-524028-9	Cable, Elevator Tab
1	MC002-524028-21	Cable/Chain, Elev. Tab
1	MC36-524000-23	Elevator Fwd
1	MC36-524000-29 <sup>2</sup>	Cable/Chain, Elev. Tab RH
1	MC36-524000-31 <sup>2</sup>	Cable/Chain, Elev. Tab LH
1	MCNAS30434-1624	Elevator Up
2	MCNAS30435-0564	Elevator
1	MCNAS31237-0204	Elevator Tab
1	MCNAS31237-0520	Elevator Tab
1	35-524647-9 <sup>4</sup>	Indicator Actuating
2	MC002-524000-23	Rudder Aft
1	MCNAS30435-1696	Rudder Fwd RH
1	MCNAS30435-1703	Rudder Fwd LH
1	MC35-524314-12	Cable/Chain, Aileron Fuslg.
1	MCNAS30422-0255	Aileron
1	MCNAS30426-1064	Aileron LH
2	MCNAS30537-0647	Aileron Aft
2	MCNAS30537-0667	Aileron Fwd
1	MCNAS30566-1035	Aileron

**Model 36 Bonanza**  
 B36TC  
 S/N EA-320, EA-378 thru EA-999

Complete Kit P/N BCKT36TC-03

Qty	Part Number	Location
1	MC106-524020-57	Cable/Chain, Elevator Tab
1	MC106-524046-7	Elevator Tab Nose Down
1	MC106-524046-9	Elevator Tab Nose Up
1	MC106-524049-1	Elevator Up Fwd
1	MC106-524049-9	Elevator Down Fwd
1	MC106-524050-1	Elevator Up Aft
1	MC36-524000-69	Cable/Chain, Elev. Tab LH
1	MC106-524050-3	Elevator Down Aft
1	MC36-524000-63	Cable/Chain, Elev. Tab RH
1	MC106-524051-7	Rudder LH
1	MC106-524051-5	Rudder RH
1	MC36-524079-5	Rudder Aft RH
1	MC36-524079-7	Rudder Aft LH
1	MC106-524019-47	Cable/Chain, Aileron Tab
1	MC106-524031-1	Cable/Chain, Aileron Tab
1	MC106-524043-11	Aileron Aft LH
1	MC106-524043-5	Aileron Aft RH
2	MC106-524043-7	Aileron Fwd LH & RH
1	MC106-524044-19	Aileron
1	MC106-524044-21	Aileron
1	MC106-524044-3	Aileron
1	MC106-524045-5	Aileron

**Model 36 Bonanza**  
 G36  
 S/N E-3630, E-3636 thru-9999

Complete Kit P/N BCKTG36-01

Qty	Part Number	Location
1	MC36-524000-63	Cable/Chain, Elevator Tab RH
1	MC106-524049-9	Elevator Down Fwd
1	MC106-524046-7	Elevator Tab Nose Down
1	MC106-524049-1	Elevator Up Fwd
1	MC36-524000-69	Cable/Chain, Elevator Tab LH
1	MC106-524046-9	Elevator Tab Nose Up
1	MC106-524050-1	Elevator Up Aft
1	MC106-524020-57	Cable/Chain, Elevator Tab
1	MC106-524050-3	Elevator Down Aft
1	MC36-524079-5	Rudder Aft RH
1	MC36-524079-7	Rudder Aft LH
1	MC106-524051-7	Rudder LH
1	MC106-524051-5	Rudder RH
1	MC106-524043-7	Aileron Fwd LH & RH
1	MC106-524045-5	Aileron
1	MC106-524044-3	Aileron
1	MC106-524019-47	Cable/Chain, Aileron Tab
1	MC106-524031-1	Cable/Chain, Aileron Tab
1	MC106-524044-19	Aileron

Continued from previous column  
**Model 36 Bonanza**  
 G36  
 S/N E-3630, E-3636 thru-9999

Complete Kit P/N BCKTG36-01

Qty	Part Number	Location
1	MC106-524043-5	Aileron Aft RH
1	MC106-524043-11	Aileron Aft LH
1	MC106-524044-21	Cable Assy

**Model 50 Twin Bonanza**  
 D50<sup>1</sup>(DH-144 thru DH-154), D50B, D50C, D50E,  
 E50, F50, H50, J50, G50<sup>1</sup>(GH-95 thru GH-119)

Part Number	Location
MCNAS30635-1172	Aileron

**Model 55**  
 95-55, 95-A55

Part Number	Location
MCNAS30435-0564	Elevator
MCNAS30444-3507	Elevator
MCNAS30534-0652	Aileron Fwd
MCNAS30534-1594	Rudder Fwd RH
MCNAS30534-1600	Rudder Fwd LH
MCNAS305-35-0672	Cable
MCNAS30555-1043	Aileron
MCNAS31237-0302	Elevator Tab Down
MCNAS31237-0323	Elevator Tab Up

**Model 55**  
 95-B55

Part Number	Location
Note 1	MCNAS30277-4040 Rudder Tab
Note 2	MCNAS30435-0564 Elevator
Note 3	MCNAS30435-0568 Elevator Aft
Note 4	MCNAS30435-0570 Elevator Aft
Note 5	MCNAS30444-3507 Elevator
	MCNAS30534-0652 Aileron Fwd
	MCNAS30534-1594 Rudder Fwd RH
	MCNAS30534-1600 Rudder Fwd LH
	MCNAS305-35-0672 Cable
	MCNAS30555-1043 Aileron
Note 6	MCNAS31237-0222 Elevator Trim
Note 7	MCNAS31237-0302 Elevator Tab Down
	MCNAS31237-0323 Elevator Tab Up

**Model 55**  
 95-C55

Part Number	Location
Note 1	TC-1608 thru TC-2456
Note 2	TC-371 thru TC-2404
Note 3	TC-2405 thru TC-2430
Note 4	TC-2431 thru TC-2456
Note 5	TC-371 thru TC-1607
Note 6	TC-2024 thru TC-2456
Note 7	TC-371 thru TC-2023

Part Number	Location
Note 1	MCNAS30435-0564 Elevator
	MCNAS30444-3511 Elevator
Note 1	MCNAS30534-0652 Aileron Fwd
Note 1	MCNAS30534-1594 Rudder Fwd RH
Note 1	MCNAS30534-1600 Rudder Fwd LH
Note 1	MCNAS305-35-0672 Cable
	MCNAS30555-1043 Aileron
	MCNAS31237-0302 Elevator Tab Down
	MCNAS31237-0323 Elevator Tab Up

Note 1: Not required for s/n TC-350.

**Model 55**  
 D55

Part Number	Location
MCNAS30435-0564	Elevator
MCNAS30444-3511	Elevator
MCNAS30534-0652	Aileron Fwd
MCNAS305-35-0672	Cable
MCNAS30534-1594	Rudder Fwd RH
MCNAS30534-1600	Rudder Fwd LH
MCNAS30555-1043	Aileron
MCNAS31237-0302	Elevator Tab Down
MCNAS31237-0323	Elevator Tab Up
Note 1	MCNAS31237-0843 Electric Trim

Note 1: TE-633 thru TE-76

**Model 55**  
 E55

Part Number	Location
Note 1	MCNAS30277-4040 Rudder Tab
Note 2	MCNAS30435-0564 Elevator
Note 3	MCNAS30435-0568 Elevator Aft
Note 4	MCNAS30435-0570 Elevator Aft
Note 5	MCNAS30444-3511 Elevator
	MCNAS30534-0652 Aileron Fwd
	MCNAS30534-1594 Rudder Fwd RH
	MCNAS30534-1600 Rudder Fwd LH
	MCNAS305-35-0672 Cable
	MCNAS30555-1043 Aileron
Note 6	MCNAS31237-0222 Elevator Trim
Note 7	MCNAS31237-0302 Elevator Tab Down
	MCNAS31237-0323 Elevator Tab Up
	MCNAS31237-0843 Electric Trim

Note 1: TE-938, TE-943 thru TE-1201  
 Note 2: TE-768 thru TE-1192  
 Note 3: TE-1193 thru TE-1196  
 Note 4: TE-1197 thru TE-1201  
 Note 5: TE-768 thru TE-937, TE-939 thru TE-942  
 Note 6: TE-1087 thru TE-1201  
 Note 7: TE-768 thru TE-1086

**Model 56 Baron**  
 56TC, A56TC

Part Number	Location
MCNAS30277-4040	Rudder Tab
MCNAS30435-0564	Elevator
MCNAS30534-0652	Aileron Fwd
MCNAS305-35-0672	Cable
MCNAS30555-1043	Aileron
MCNAS31237-0302	Elevator Tab Down
MCNAS31237-0342	Elevator Tab Up

**Model 58 Baron**  
 58

Part Number	Location
Note 1	MC106-524049-1 Elevator Up Fwd
Note 1	MC106-524049-9 Elevator Down Fwd
Note 1	MC106-524050-1 Elevator Up Aft
Note 1	MC106-524050-3 Elevator Down Aft
Note 2	MCNAS30277-4240 Rudder Tab
Note 3	MCNAS30435-0564 Elevator
Note 4	MCNAS30435-0568 Elevator Aft
Note 5	MCNAS30435-0570 Elevator Aft
Note 2	MCNAS30534-0652 Aileron Fwd
Note 2	MCNAS30534-1696 Rudder RH
Note 2	MCNAS30534-1703 Rudder LH
Note 2	MCNAS305-35-0672 Cable
Note 2	MCNAS30555-1043 Aileron
Note 6	MCNAS31237-0222 Elevator Trim
Note 7	MCNAS31237-0302 Elevator Tab Down
Note 2	MCNAS31237-0523 Elevator Trim Up
	MCNAS31237-0843 Electric Trim

Note 1: TH-1389, TH-1396 thru TH-2124  
 Note 2: TH-1 thru TH-1388, TH-1390 thru TH-1395  
 Note 3: TH-1 thru TH-1274  
 Note 4: TH-1275 thru TH-1314  
 Note 5: TH-1315 thru TH-1388, TH-1390 thru TH-1395  
 Note 6: TH-790 thru TH-1388, TH-1390 thru TH-1395  
 Note 7: TH-1 thru TH-789

**Model 58 Baron**  
 58P

Part Number	Location
Note 1	MC106-524049-1 Elevator Up Fwd
Note 1	MC106-524049-9 Elevator Down Fwd
Note 2	MCNAS30435-0564 Elevator
Note 2	MCNAS30534-1696 Rudder RH
Note 2	MCNAS30534-1703 Rudder LH
Note 2	MCNAS30555-1043 Aileron
Note 1	TJ-436, TJ-444 thru TJ-497
Note 2	TJ-3 thru TJ-435, TJ-437 thru TJ-443

<sup>1</sup> Partial model eligibility  
<sup>2</sup> Cable/Chain Assembly

**Model 58 Baron**  
 58TC

Part Number	Location
Note 1	MC106-524049-1 Elevator Up Fwd
Note 1	MC106-524049-9 Elevator Down Fwd
Note 2	MCNAS30277-4240 Rudder Tab
Note 3	MCNAS30435-0564 Elevator
Note 3	MCNAS30534-1696 Rudder RH
Note 4	MCNAS30534-1703 Rudder LH
Note 4	MCNAS30555-1043 Aileron
Note 1	TK-147, TK-151
Note 2	TK-53 thru TK-146, TK-148 thru TK-150
Note 3	Not required for s/n TK-151.
Note 4	Not required for s/n TK-147 or TK-151.

**Model 60 Duke**  
 B60

Part Number	Location
MCNAS30534-0652	Aileron Fwd
MCNAS305-35-0672	Cable

**Model 76 Duchess**  
 76

Part Number	Location
MCNAS31424-1152	Stabilator
MCNAS31424-1242	Rudder Fwd RH
MCNAS31425-1220	Rudder Fwd LH
MCNAS31425-1411	Stabilator/Elevator Fwd

**Model 90 King Air**  
 65-90, 65-A90, C90, C90A,  
 C90B<sup>1</sup>(LJ-1288 thru LJ-1305,  
 LJ-1307 thru LJ-1315, LJ-1317, LJ-1319,  
 LJ-1367 thru LJ-1755), C90GT, E90

Part Number	Location
MCNAS30635-1172	Aileron

<sup>1</sup> Partial model eligibility  
<sup>2</sup> Cable/Chain Assembly  
<sup>3</sup> Pending FAA-PMA approval  
<sup>4</sup> Not available from McFarlane

Flight Control System



# Flight Control System

## Flight Control Cables - Beechcraft

Model 90 King Air F90		
Part Number	Location	
MCNAS30266-1814	Elevator Tab	
MCNAS30277-1700	Elevator Tab	
MCNAS30635-1172	Aileron	

Model 100 King Air 100,A100,B100		
Part Number	Location	
MC99-524015	Aileron Tab	
MCNAS30635-1172	Aileron	

Model 200 King Air 200,200C,200CT,200T(All except BT-28), B200, B200C,B200CT,B200T		
Part Number	Location	
MC101-524088-1	Aileron Tab	
Note 1,2 MC1781-1	Elevator Tab	
MCNAS30266-1814	Elevator Tab	
Note 2 MCNAS30277-1700	Elevator Tab	
MCNAS30635-1172	Aileron	

Note 1: Replaces: (1) NAS302-67-6643  
(2) 35-524288 Stop Screw, (2) 35-524287 Stop Nut.  
Note 2: Model 200 s/n BB-39 thru BB-912.

Model 300 King Air 300,300LW		
Part Number	Location	
MCNAS30266-1814	Elevator Tab	
MCNAS30267-6643	Elevator Tab	
MCNAS30277-1700	Elevator Tab	
MCNAS30624-1176	Aileron	
MCNAS30635-1172	Aileron	

Model 300 King Air B300,B300C(All except FN-1)		
Part Number	Location	
MC101-524088-1	Aileron Tab	
MCNAS30266-1814	Elevator Tab	
MCNAS30277-1700	Elevator Tab	
MCNAS30624-1176	Aileron	
MCNAS30635-1172	Aileron	

Model 1900 Airliner 1900,1900C(UB-1 thru UB-74)		
Part Number	Location	
MCNAS30266-1312	Elevator Tab	
MCNAS30277-1307	Elevator	
MCNAS30624-1176	Aileron	
MCNAS30635-1172	Aileron	

Model 45 and T-34 A45 (T-34A), D45 (T-34B)		
Part Number	Location	
MCNAS305-34-0640	Aileron	
MCNAS305-35-0672	Aileron	
MCNAS305-25-0546	Aileron	
MCNAS305-35-0546	Aileron	
MCNAS305-24-0514	Aileron	
MCNAS305-34-0514	Aileron	
Note 2 MCNAS305-34-0826	Elevator	
MCNAS305-35-0576	Elevator	
Note 2 MCNAS305-34-0996	Elevator	
MCNAS305-35-0564	Elevator Aft	
Note 1 MCNAS305-34-1010	Elevator Fwd	
Note 1 MCNAS305-34-0840	Elevator Fwd	
MCNAS304-34-1271	Rudder	
MCNAS304-35-0712	Rudder	
Note 3 MCNAS304-33-0311	Rudder	
Note 3 MCNAS304-34-1116	Rudder	

Note 1: For model A45 (T-34A) only.  
Note 2: For model D45 (T-34B) only.  
Note 3: For aircraft with Beechcraft Kit 45-322A installed.

Model T-34 T-34C, 34C, T-34C-1		
Part Number	Location	
MCNAS305-34-0640	Aileron	
MCNAS305-35-0672	Aileron	
Note 1 MCNAS305-25-0546	Aileron	
Note 1 MCNAS305-35-0546	Aileron	
Note 1 MCNAS305-24-0514	Aileron	
Note 1 MCNAS305-34-0514	Aileron	
MC104-524023-3	Aileron Trim	
MC104-524023-5	Aileron Trim	
MCNAS305-35-0996	Elevator	
MCNAS305-34-0826	Elevator	
MCNAS305-34-0564	Elevator	
MCNAS305-35-0576	Elevator	
MC104-524020-9	Elevator Trim	
MC104-524020-11	Elevator Trim	
MC104-524046-3	Elevator Trim	
MC104-524046-5	Elevator Trim	
MC104-524021-3	Rudder Trim	
MC104-524021-5	Rudder Trim	
MC104-524022-3	Rudder Trim	
MC104-524022-7	Rudder Trim	

Note 1: For model T-34C only.

**General Beechcraft Cable**  
**Notes: Corrosion Protection**  
All Beechcraft cables are made from galvanized steel cable and coated with a modified MIL-PRF-16173 compound. This is the same process used on Beechcraft original cables. It provides additional corrosion protection beyond the standard MIL-SPEC rust preventive oil. This provides both exceptional wear resistance and corrosion protection for many years.

**Cable Stop P/N MC6057**

- Improved for more consistent holding strength
- Used on the assist step cable on 35, A35 and C35 Beech Bonanzas
- One McFarlane MC6057 cable stop replaces both Beechcraft 35-524287 nut and 35-524288 screw part numbers
- Also included on select cable assemblies as required



**Bulk Cable**  
**Great prices on galvanized or stainless steel!**  
All cable meets MIL-DTL-83420 certification. Manufacturer certification is provided with every order.

- Direct mill purchases let us sell for less!
- Prepackaged in 100 and 500 foot lengths
- Custom lengths available

Diameter	Cable	Galvanized	Stainless
1/16	1X19	•	
	7X7	•	•
	7X19	•	•
1/8	1X19	•	
	7X19	•	•
1/4	7X19	•	•
	1X19	•	
3/32	7X7	•	•
	7X19	•	•
	7X19	•	•
3/16	7X19	•	•
3/8	7X19	•	•
5/32	7X19	•	•
5/16	7X19	•	•



FAA-PMA Approved

## Pulleys and Pulley Kits for Cessna Aircraft

McFarlane stocks all pulleys required for Cessna single engine aircraft. Our MCS378 series pulleys replace the AN, NAS and S378 series pulleys commonly used on the Cessna aircraft. Pulley kits are available that contain all of the pulleys and cotter pins required for one aircraft.



### Improved Bearings

All MCS378 series FAA-PMA pulleys used in McFarlane pulley kits feature high quality sealed precision ball bearings. This style of bearing is far superior to low grade, open seal bearings used in the cheap Cessna S378-()L light duty series pulleys that they replace.

### Available Pulley Part Numbers

1660433-1, 1660433-2, AN210-1B, AN210-2B, AN210-3B, AN210-4B, AN210-5B, AN220-1, AN220-2, AN220-3, AN220-4, MCS378-1, MCS378-2, MCS378-3, MCS378-4, MCS378-5, MS20219-1, MS20219-2, MS20219-3, MS20219-4, MS20219-5, MS20219A1, MS20219A2, MS20219A3, MS20219A4, MS20219A5, MS20220-1, MS20220-2, MS20220-3, MS20220-4, MS24566-1B, MS24566-2B, MS24566-3B, MS24566-4B, MS24566-5B, NAS383-1, NAS383-2, NAS383-3, NAS383-4, S1052-1, S1710-1, S378-4S, S394

McFarlane Pulley Oil, will not dry out and get sticky. See the following page.

### Approved Replacements for Cessna Pulleys

Cessna Model/Series	Part Number*	Replaces Cessna Part Number*
120,140,140A,150,A150,A-150, F150,FA150,FRA150,152,A152,F152,FA152,170,172,F172, FR172, 172RG,FP172,P172,R172,175,177,177RG,F177RG,180,182,A182,F182,FR182,R182, TR182,T182,185,A185,188, A188,A-A188,T188,205,206,P206,TU206,T206,TP206,U206,207, T207,208,210,P210,T210,T303,310,T310,320,335,336,337,F337,P337,FP-337,T337,O-2, 340,401,402,404,411,414,421,425,441,500,501	MCS378-1	S378-1 and S378-1L
	MCS378-2	S378-2, A124, AN210-2B and NAS383-2
	MCS378-3	S378-3, S378-3L, A130, AN210-3B, BB-208 and NAS383-3
	MCS378-4	S378-4, A114, AN210-4B and NAS383-4
	MCS378-5	S378-5

\*Replaces the listed Cessna part numbers in the specific aircraft illustrated parts catalogs. Installer must verify applicability prior to installation.

### Available Cotter Pin Part Numbers

MS24665-132, MS24665-134, MS24665-138, MS24665-140, MS24665-143, MS24665-144, MS24665-155, MS24665-170, MS24665-24, MS24665-281, MS24665-283, MS24665-285, MS24665-287, MS24665-289, MS24665-292, MS24665-295, MS24665-353, MS24665-355, MS24665-357, MS24665-360, MS24665-5, MS24665-7, MS24665-71.



Pulleys and cotter pins available as convenient kits. Pulleys can be purchased separately. Cotter Pins can be purchased in quantities of 10 or 25 each depending on part number.

Model	Serial Number	Kit P/N	Quantity per Kit (Applicable cotter pins also included)					Other Pulleys
			MCS378-1	MCS378-2	MCS378-3	MCS378-4	MCS378-5	
120/140	8000-15075	PULL-KT-01	8	2	10	10	1	
140A	15200-15724	PULL-KT-02		2	8	12	1	(8) NAS383-1
150	17001-59018	PULL-KT-03	8	13	10	12	3	
150A,B,C	15059019-15060087	PULL-KT-04	8	13	10	10	3	
150D, E	15060088-15061083	PULL-KT-05	8	13	10	4	1	(6) MS20220-2
150E	15061084-15061532	PULL-KT-06	8	13	10	4		(6) MS20220-2
150F,G	15061533-15067198	PULL-KT-07	10	10	13	4		(7) MS20220-2
150H	15067199-15069308	PULL-KT-08	14	10	13	4		(7) MS20220-2
150J	15069309-15071128	PULL-KT-09	14	8	13	4		(7) MS20220-2
150K, L	15071129-15074399	PULL-KT-10	14	8	13	4		(7) MS20220-2
A150K, L	A15000001-A1500387	PULL-KT-10	14	8	13	4		(7) MS20220-2
F150K, L	F15000530-F15000943	PULL-KT-10	14	8	13	4		(7) MS20220-2
FA150K, L	FA1500001-FA1500120	PULL-KT-10	14	8	13	4		(7) MS20220-2
FRA150L	FRA1500121-FRA1500211	PULL-KT-10	14	8	13	4		(7) MS20220-2
150L	15074400-15074661	PULL-KT-11	14	10	11	4		(7) MS20220-2
A150L	A1500388-A1500415	PULL-KT-11	14	10	11	4		(7) MS20220-2
F150L	F1500944-F15001062	PULL-KT-11	14	10	11	4		(7) MS20220-2
150L, M	15074662-15079405	PULL-KT-12	14	10	12	4		(7) MS20220-2
FRA150L, M	FRA1500212-FRA1500336	PULL-KT-12	14	10	12	4		(7) MS20220-2
152	15279406-15286033	PULL-KT-13	14	10	12	4		(7) MS20220-2
A152	A1520735-A1521049	PULL-KT-13	14	10	12	4		(7) MS20220-2
F152	F15201429-F015201952	PULL-KT-13	14	10	12	4		(7) MS20220-2
FA152	FA1520337-FA1520387	PULL-KT-13	14	10	12	4		(7) MS20220-2
170	18000-18729	PULL-KT-14		4	7	16	2	(8) NAS383-1
170A	18730-20266	PULL-KT-15			13	14		(8) NAS383-1
170B	20267-27169	PULL-KT-16	8	11	9	22	4	(8) NAS383-1
172A,B,C	28000-17249544	PULL-KT-17	8	11	10	18	4	
172D	17249545-17250572	PULL-KT-18	9	11	10	18	4	
F172D	F1720001-F1720018	PULL-KT-18	9	11	10	18	4	
FP172	FP1720001-FP1720003	PULL-KT-18	9	11	10	18	4	
P172	P17257120-P17257188	PULL-KT-18	9	11	10	18	4	
172E	17250573-17251822	PULL-KT-19	9	11	10	16	4	
F172E	F1720019-F1720085	PULL-KT-19	9	11	10	16	4	
172F,G,H,I,K,L,M	17251823-17263458	PULL-KT-20	13	2	10	16	3	(2) MS20220-1
F172F,G,H,K,L,M	F1720086-F17201234	PULL-KT-20	13	2	10	16	3	(2) MS20220-1
FR172E,F,G,H,J	FR1720001-FR1720590	PULL-KT-21	12	2	10	16	3	(2) MS20220-1
172M,N,P	17263459-17276673	PULL-KT-22	13	2	10	16	3	(2) MS20220-1, (1) S1710-1
F172M,N,P	F17201235-F17202254	PULL-KT-22	13	2	10	16	3	(2) MS20220-1, (1) S1710-1
172R,S	17280001 & On	PULL-KT-19	9	11	10	16	4	
175A,B,C	55001-17557119	PULL-KT-17	8	11	10	18	4	
180A,B	30000-50661	PULL-KT-24	5	11	7	20	4	
180C,D,E	50662-18051183	PULL-KT-25	5	12	7	20	4	
180F,G	18051184-18051445	PULL-KT-26	5	12	7	20	4	(1) MS20220-2
	18051446-18051607	PULL-KT-27	5	12	7	22	4	(1) MS20220-2
180H	18051608-18052206	PULL-KT-28	5	12	7	22	1	8 (1) MS20220-2
180H, J	18052207-18052384	PULL-KT-83	5	12	7	22	1	8 (1) MS20220-2, (1) S1710-1
180, K	18052385-18053203	PULL-KT-29	5	11	7	22	1	8 (2) MS20220-2, (1) S1710-1
182,A,B	33000-52358	PULL-KT-34	5	11	7	20	1	4
182C,D	52359-18053598	PULL-KT-35	5	12	7	20	1	4
182E	18253599-18253929	PULL-KT-36	6	1	6	10	3	(6) MS20220-2, (1) S1052-1
182E, F,G,H,J,K	18253930-18258505	PULL-KT-85	11	3	6	10	3	(6) MS20220-2, (1) S1052-1

Partial model eligibility

Eligibility continues on next page



# Flight Control System Pulleys for Cessna Aircraft



FAA-PMA Approved

Continued from previous page		Quantity per Kit (Applicable cotter pins also included)								
Model	Serial Number	Kit P/N	MCS378-1	MCS378-2	MCS378-3	MCS378-4	MCS378-5	S394	Other Pulleys	
182L,M,N	18258506-18260445	PULL-KT-37	6	3	6	8		3	(8) MS20220-2, (1) S1052-1	
182N	18260446-18260669	PULL-KT-38	8	3	6	8		3	(8) MS20220-2, (1) S1052-1	
182N	18260670-18262465	PULL-KT-86	8	3	6	8		3	(8) MS20220-2, (1) S1052-1, (1) S1710-1	
182P,Q,R	18262466-18268615	PULL-KT-39	13	3	6	8		3	(8) MS20220-2, (1) S1052-1, (1) S1710-1	
T182	18267716-18268615	PULL-KT-39	13	3	6	8		3	(8) MS20220-2, (1) S1052-1, (1) S1710-1	
182S, 182T	18208001 & On	PULL-KT-80	13	3	6	8		3	(9) MS20220-2, (1) S1052-1, (1) S1710-1	
F182P,Q	F1820001-F18200169	PULL-KT-39	13	3	6	8		3	(8) MS20220-2, (1) S1052-1, (1) S1710-1	
FR182	FR1820001-FR18200070	PULL-KT-40	3	1	16	16		3	(8) MS20220-2, (1) S1052-1, (1) S1710-1	
R182,TR182	R1820001-R18202041	PULL-KT-40	3	1	16	16		3	(8) MS20220-2, (1) S1052-1, (1) S1710-1	
T182	T1820801 & On	PULL-KT-80	13	3	6	8		3	(9) MS20220-2, (1) S1052-1, (1) S1710-1	
185,A,B,C	1850001-1850776	PULL-KT-30	5	12	7	20	1	4	(1) MS20220-2	
185D	1850777-1850967	PULL-KT-31	5	12	7	22	1	4	(1) MS20220-2	
185E,A185E	1850968-18501901	PULL-KT-32	5	12	7	22	1	8	(1) MS20220-2	
A185E,F	18501902-18502310	PULL-KT-84	5	12	7	22	1	8	(1) MS20220-2, (1) S1710-1	
A185F	18502311-18504448	PULL-KT-33	5	11	7	22	1	8	(2) MS20220-2, (1) S1710-1	
188	1880001-1880317	PULL-KT-41	2	5		6		4	(4) 1660433-1, (8) MS20220-1, (2) MS20220-2, (1) MS20220-4	
188	1880318-1880572	PULL-KT-42	4	5		6		4	(4) 1660433-1, (8) MS20220-1, (2) MS20220-2, (1) MS20220-4	
188A	1880573-1880707	PULL-KT-43	4	5		6		6	(4) 1660433-1, (8) MS20220-1, (2) MS20220-2, (1) MS20220-4, (1) S1052-1	
188A	1880708-18801348	PULL-KT-44	4	5		6		6	(4) 1660433-2, (10) MS20220-2, (1) MS20220-4, (2) S1052-1	
188A	18800967T-188001348T	PULL-KT-44	4	5		6		6	(4) 1660433-2, (10) MS20220-2, (1) MS20220-4, (2) S1052-1	
188B	18801349-18801402	PULL-KT-45	4	5		6		6	(4) 1660433-2, (1) MS20220-1, (10) MS20220-2, (1) MS20220-4, (2) S1052-1	
188B	18801349T-18801402T	PULL-KT-45	4	5		6		6	(4) 1660433-2, (1) MS20220-1, (10) MS20220-2, (1) MS20220-4, (2) S1052-1, (1) S1710-1	
188B	18801403-18803856	PULL-KT-46	4	5		6		6	(4) 1660433-2, (1) MS20220-1, (10) MS20220-2, (1) MS20220-4, (2) S1052-1, (1) S1710-1	
188B	18801403T-18803968T	PULL-KT-46	4	5		6		6	(4) 1660433-2, (1) MS20220-1, (10) MS20220-2, (1) MS20220-4, (2) S1052-1, (1) S1710-1	
T188C	T18803297T-T18803968T	PULL-KT-6	4	5		6		6	(4) 1660433-2, (1) MS20220-1, (10) MS20220-2, (1) MS20220-4, (2) S1052-1, (1) S1710-1	
210-5 (205), 210-5A (205A)	2050001-2050577	PULL-KT-47	11	3	6	22		3	(5) MS20220-2, (1) S1052-1	
206,U206,A,B	2060001-U2060914	PULL-KT-48	7	4	6	26		6	(4) MS20220-1, (9) MS20220-2, (1) S1052-1	
TU206A,B	2060438-U2060914	PULL-KT-48	7	4	6	26		6	(4) MS20220-1, (9) MS20220-2, (1) S1052-1	
P206,TP206A,B	P2060001-P2060419	PULL-KT-48	7	4	6	26		6	(4) MS20220-1, (9) MS20220-2, (1) S1052-1	
U206,TU206C,D,E	U2060915-U20601667	PULL-KT-49	10	4	6	26		6	(4) MS20220-1, (11) MS20220-2, (1) S1052-1	
P206,TP206C,D,E	P2060420-P2060647	PULL-KT-49	10	4	6	26		6	(4) MS20220-1, (11) MS20220-2, (1) S1052-1	
U206E,TU206E	U20601668-U20601700	PULL-KT-50	10	4	6	26		6	(4) MS20220-1, (9) MS20220-2, (1) S1052-1, (1) S1710-1	
U206F,TU206F	U20601701-U20601874	PULL-KT-51	8	4	6	26		6	(4) MS20220-1, (11) MS20220-2, (1) S1052-1, (1) S1710-1	
U206F	U20601875-U20602199	PULL-KT-52	7	4	6	26		6	(4) MS20220-1, (11) MS20220-2, (1) S1052-1, (1) S1710-1	
U206F	U20602200-U20602579	PULL-KT-53	7	2	6	26		6	(4) MS20220-1, (9) MS20220-2, (2) MS20220-4, (1) S1052-1, (1) S1710-1	
U206F,G	U20602580-U20603798	PULL-KT-54	7	1	6	20		6	(4) MS20220-1, (9) MS20220-2, (2) MS20220-4, (1) S1052-1, (1) S1710-1	
U206G	U20603799-U20607020	PULL-KT-55	7		6	22		6	(4) MS20220-1, (8) MS20220-2, (2) MS20220-4, (1) S1052-1, (1) S1710-1	
T206H	T20608001 & On	PULL-KT-56	7		6	18		4	(4) MS20220-1, (8) MS20220-2, (2) MS20220-4, (1) S1052-1, (1) S1710-1	
T207	T20608001 & On	PULL-KT-56	7		6	18		4	(4) MS20220-1, (8) MS20220-2, (2) MS20220-4, (1) S1052-1, (1) S1710-1	
207	20700001-20700204	PULL-KT-57	12	1	4	21		6	(4) MS20220-1, (11) MS20220-2, (7) S1052-1, (2) S1710-1	
207	20700205-20700227	PULL-KT-58	12	1	4	21		6	(4) MS20220-1, (11) MS20220-2, (7) S1052-1, (3) S1710-1	
207	20700228-20700267	PULL-KT-59	9	1	4	21		6	(4) MS20220-1, (9) MS20220-2, (7) S1052-1, (3) S1710-1	
207	20700268-20700390	PULL-KT-60	9	1	6	15		6	(4) MS20220-1, (9) MS20220-2, (2) MS20220-4, (5) S1052-1, (3) S1710-1	
207	20700391-20700788	PULL-KT-61	9	1	6	17		6	(4) MS20220-1, (8) MS20220-2, (2) MS20220-4, (5) S1052-1, (3) S1710-1	
208	20800001 thru 20800145	PULL-KT-87			3	13			(6) MS20220-1, (2) MS20220-3, (18) S378-4S	
208	20800146 thru 20899999	PULL-KT-88			2	13			(6) MS20220-1, (2) MS20220-3, (18) S378-4S	
208B	All	PULL-KT-89			2	13			(6) MS20220-1, (2) MS20220-3, (19) S378-4S	
210,A	57001-21057840	PULL-KT-62	5	4	11	22		3	(9) MS20220-2, (2) S1052-1	
210B,C	21057841-21058220	PULL-KT-63	7	4	6	28		3	(4) MS20220-2, (2) S1052-1	
210D,E,F	21058221-21058818	PULL-KT-64	7	3	6	28		6	(4) MS20220-1, (9) MS20220-2, (1) S1052-1	
T210G	T2100001-T2100197	PULL-KT-64	7	3	6	28		6	(4) MS20220-1, (9) MS20220-2, (1) S1052-1	
210G	21058819-21058936	PULL-KT-65	7		6	28		2	(12) MS20220-2, (2) MS20220-3, (8) S1710-1	
T210G	T2100198-T2100307	PULL-KT-65	7		6	28		2	(12) MS20220-2, (2) MS20220-3, (8) S1710-1	
210H	21058937-210859030	PULL-KT-66	11		6	28		2	(12) MS20220-2, (2) MS20220-3, (8) S1710-1	
210H	21059031-21059061	PULL-KT-67	11		6	28		2	(11) MS20220-2, (2) MS20220-3, (4) S1710-1	
210H	T2100308-T2100378	PULL-KT-66	11		6	28		2	(12) MS20220-2, (2) MS20220-3, (8) S1710-1	
210H	T2100379-T2100392	PULL-KT-67	11		6	28		2	(11) MS20220-2, (2) MS20220-3, (4) S1710-1	
210J	21059062-21059199	PULL-KT-68	15		6	28		2	(11) MS20220-2, (2) MS20220-3, (4) S1710-1	
T210J	T2100393-T2100454	PULL-KT-68	15		6	28		2	(11) MS20220-2, (2) MS20220-3, (4) S1710-1	
210K,L	21059200-21060089	PULL-KT-69	14	1	7	26		2	(11) MS20220-2, (2) MS20220-3, (4) S1710-1	
210L,M,N	21060090-21064135	PULL-KT-71	12	1	7	28		2	(11) MS20220-2, (2) MS20220-3, (4) S1710-1	
210N	21064136-21064897	PULL-KT-77	12	1	7	28		2	(11) MS20220-2, (6) MS20220-3, (5) S1710-1	
210R,T210R	21064898-21065009	PULL-KT-78	8		7	28		2	(9) MS20220-2, (4) MS20220-3, (5) S1710-1	
P210N	P21000001-P21000834	PULL-KT-81	12	1	7	28		2	(11) MS20220-2, (2) MS20220-3, (5) S1710-1	
P210R	P21000835-P21000874	PULL-KT-82	8		7	28		2	(9) MS20220-2, (4) MS20220-3, (5) S1710-1	

■ Partial model eligibility

## D A M™ Aircraft Pulley Oil

New name, same dependable oil!  
Featuring a re-designed needle oiler.  
Great for unreachable areas with traditional applicators.

- Does not dry out and get sticky
- Loosens old stiff pulley grease
- Save the labor of re-oiling the control system every year!



20" Extension P/N 7249  
now sold separately!



Qty	Description
<b>P/N PULLEY OIL KIT</b>	
1	Pint, Pulley Oil
1	Needle Oiler with Extension, .34 fl oz (10mL)
<b>P/N PULLEY OILER KIT</b>	
1	Needle Oiler with Extension, .34 fl oz (10mL)
<b>P/N PULLEY OIL</b>	
1	Pint, Pulley Oil





FAA-PMA Approved

## General Description of Pulleys

- MCS378- Series: Phenolic flight control pulleys with ball bearings. FAA-PMA approved replacements for the Cessna S378, A-/BB-, and NAS383- series pulleys on Cessna Aircraft
- MS20219- Series: Pulley with high pressure laminated phenolic sheave and fixed ball bearing with contact seal. These supersede the AN219- Series pulleys of like dash number
- MS20219A-Series: Pulley with aluminum alloy sheave and fixed ball bearing with contact seal. Sheave anodized per MIL-A-8625.
- MS20220- Series: Phenolic flight control pulleys with ball bearings. These supersede the AN220- Series pulleys of like dash number.
- MS24566- Series: Phenolic flight control pulleys with ball bearings. These supersede the AN210- series pulleys of like dash number
- NAS383- Series: Phenolic commercial grade pulleys with graphite impregnated bronze sleeve bearings. These are typically used with a bushing. The MCS378- series pulleys supersede these for most Cessna aircraft applications. The MCS378 pulley replaces both the NAS383 pulley and it's bushing
- S394, S1052-1, and S1710-1: Cessna nylon pulleys with no bearings
- S378-4S: Cessna pulley similar to S378-4 but smaller diameter. Used on 177RG s/n 177RG0202 and on, and F177RG0038 and on for routing stabilator, stabilator trim, and rudder cables. Six required per aircraft
- 1660433- Series: Cessna phenolic pulleys with ball bearings



MCS378 Series Pulley



MS20219 Series Pulley

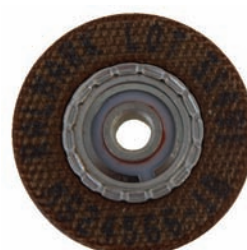

MS24566 Series Pulley

Part Number	Cable Diameter	Outside Diameter	Groove Diameter	Bore Diameter	Pulley Width	Hub Width	Load Limit	Superseded by
A-114	3/16	3.500	2.875	0.380	0.443	----	---	MCS378-4 <sup>1</sup>
A-124	3/32	2.500	2.000	0.255	0.270	----	---	MCS378-2 <sup>1</sup>
A-130	3/16	2.000	1.375	0.380	0.433	----	---	MCS378-3 <sup>1</sup>
AN210-1A	1/16, 5/64, 3/32	1.250	----	0.1900	0.250	0.297	185	MS24566-1B <sup>2</sup>
AN210-2A	1/16, 5/64, 3/32	2.500	----	0.1900	0.250	0.297	500	MS24566-2B <sup>2</sup>
AN210-3A	1/8, 5/32, 3/16	2.000	----	0.2500	0.422	0.484	450	MS24566-3B <sup>2</sup>
AN210-4A	1/8, 5/32, 3/16	3.500	----	0.2500	0.422	0.484	1200	MS24566-4B <sup>2</sup>
AN210-1B	1/16, 5/64, 3/32	1.250	0.972	0.1900	0.250	0.297	300	MS24566-1B
AN210-2B	1/16, 5/64, 3/32	2.500	2.222	0.1900	0.250	0.297	500	MS24566-2B
AN210-3B	1/8, 5/32, 3/16	2.000	1.510	0.2500	0.422	0.484	600	MS24566-3B
AN210-4B	1/8, 5/32, 3/16	3.500	3.010	0.2500	0.422	0.484	1200	MS24566-4B
AN210-5B	3/16, 7/32, 1/4	5.000	4.374	0.3750	0.500	0.620	3000	MS24566-5B
AN220-1	1/8, 5/32, 3/16	1.755	1.255	0.3125	0.422	0.625	500	MS20220-1
AN220-2	1/8, 5/32, 3/16	3.005	2.505	0.3125	0.422	0.625	1680	MS20220-2
AN220-3	1/8, 5/32, 3/16	4.255	3.755	0.3125	0.422	0.625	2500	MS20220-3
AN220-4	1/8, 5/32, 3/16	5.505	5.005	0.3125	0.422	0.625	2500	MS20220-4
BB-208	----	----	----	----	----	----	---	MCS378-3 <sup>1</sup>
MCS378-1	1/16, 5/64, 3/32	1.250	0.972	0.1900	0.250	0.297	300	
MCS378-2	1/16, 5/64, 3/32	2.500	2.222	0.1900	0.250	0.297	500	
MCS378-3	1/8, 5/32, 3/16	2.000	1.510	0.2500	0.422	0.484	600	
MCS378-4	1/8, 5/32, 3/16	3.500	3.010	0.2500	0.422	0.484	1200	
MCS378-5	3/16, 7/32, 1/4	5.000	4.374	0.3750	0.500	0.620	3000	
MS20219-1, MS20219A1	1/16, 3/32	1.312	1.000	0.2500	0.310	0.438	480	
MS20219-2, MS20219A2	1/16, 3/32	1.750	1.438	0.2500	0.310	0.438	480	
MS20219-3, MS20219A3	1/16, 3/32	1.750	1.438	0.6250	0.310	0.438	480	
MS20219-4, MS20219A4	1/16, 3/32	2.625	2.312	0.2500	0.310	0.438	920	
MS20219-5, MS20219A5	1/16, 3/32	2.625	2.312	0.6250	0.310	0.438	920	
MS20220-1	1/8, 5/32, 3/16	1.755	1.255	0.3125	0.422	0.625	500	
MS20220-2	1/8, 5/32, 3/16	3.005	2.505	0.3125	0.422	0.625	1680	
MS20220-3	1/8, 5/32, 3/16	4.255	3.755	0.3125	0.422	0.625	2500	
MS20220-4	1/8, 5/32, 3/16	5.505	5.005	0.3125	0.422	0.625	2500	
MS24566-1B	1/16, 5/64, 3/32	1.250	0.972	0.1900	0.250	0.297	300	
MS24566-2B	1/16, 5/64, 3/32	2.500	2.222	0.1900	0.25	0.297	500	
MS24566-3B	1/8, 5/32, 3/16	2.000	1.510	0.2500	0.422	0.484	600	
MS24566-4B	1/8, 5/32, 3/16	3.500	3.010	0.2500	0.422	0.484	1200	
MS24566-5B	3/16, 7/32, 1/4	5.000	4.374	0.3750	0.500	0.620	3000	
NAS383-1	3/32	1.250	0.875	0.255	0.270	----	---	
NAS383-2	3/32	2.500	2.000	0.255	0.270	----	---	MCS378-2 <sup>1</sup>
NAS383-3	3/16	2.000	1.375	0.380	0.443	----	---	MCS378-3 <sup>1</sup>
NAS383-4	3/16	3.500	2.875	0.380	0.443	----	---	MCS378-4 <sup>1</sup>
S378-1 and -1L	1/16, 5/64, 3/32	1.250	0.972	0.1900	0.250	0.297	300	MCS378-1 <sup>1</sup>
S378-2	1/16, 5/64, 3/32	2.500	2.222	0.1900	0.250	0.297	500	MCS378-2 <sup>1</sup>
S378-3 and -3L	1/8, 5/32, 3/16	2.000	1.510	0.2500	0.422	0.484	600	MCS378-3 <sup>1</sup>
S378-4	1/8, 5/32, 3/16	3.500	3.010	0.2500	0.422	0.484	1200	MCS378-4 <sup>1</sup>
S378-4S	1/8, 5/32, 3/16	~3.0	~2.5	0.2500	0.422	0.484	?	
S378-5	3/16, 7/32, 1/4	5.000	4.374	0.3750	0.500	0.620	3000	MCS378-5 <sup>1</sup>
S394	-----	1.000	0.750	0.250	0.410	0.420	----	
S1052-1	-----	1.060	0.560	0.250	0.690	0.750	----	
S1710-1	-----	0.750	0.560	0.250	0.410	0.410	----	
1660433-1	-----	1.250	1.000	0.190	0.250	0.300	----	
1660433-2	-----	2.250	2.250	0.190	0.250	0.300	----	

Notes:

<sup>1</sup> Cessna aircraft only

<sup>2</sup> Not official supersedure. They are dimensionally identical except the MS24566 pulleys have superior bearings.

The listed dimensions and loads are for reference and identification only and are not guaranteed to be accurate.

## Hardware

Over 100 certified aircraft control cable hardware part numbers in STOCK at discounted prices!!

- Balls, BM Series
- Balls, Single Shank, MS20664 Series
- Balls, Double Shank, MS20663 Series
- Barrels, Brass, MS21251 Series
- Bushings, AN111 Series
- Locking Clips, MS21256 Series
- Shackles, AN115 Series
- Sleeves, Tin and Zinc, MS51844 Series
- Straps, Eye and Fork NAS1435 Series
- Terminals, Eye, MS20668 Series
- Terminals, Fork, MS20667 Series
- Terminals, Stud, MS21259 Series
- Terminals, Turnbuckle MS21260 Series
- Thimbles, AN100 Series
- Turnbuckles, Clevis End, MS21252 Series
- Turnbuckles, Eye end for Pin, MS21254 Series
- Turnbuckles, Eye end for wire rope, MS21255 Series
- Special Terminals

**McFarlane now manufactures NAS1435 and DOD QPL-781 qualified terminals**



## Rudder Pedals for Cessna Aircraft

Completely New Rudder Pedal P/N AP2000-01

- Less money and longer life!
- Bronze bushings at the pivot points resist wear and vibration for longer pedal life.
- Precision cast heat treated aluminum alloy.
- Powder coat finish for durability and corrosion protection.
- FAA-PMA direct replacement for Cessna P/N1460320-1.



**Bronze bushings for a longer life!**

**Now manufactured by McFarlane!**

## Rudder Pedal Bar

Avoid risk of costly damage during assembly

P/N AD1260558-1 (LH)  
P/N AD1260558-2 (RH)

Each bar includes 2 ea. P/N S1003-43A bearings and 1 ea. P/N 1260419-1 tube pre-assembled. This avoids damage commonly caused while pressing the bearings during installation.

FAA-PMA



Part Number  
AD1260558-1  
AD1260558-2

Aircraft Model	AD1260558-1	AD1260558-2
210-5 (205), 210-5A (205A)	•	•
206, U206G, TU206G	•	•
206H, T206H	•	•
207A, T207A	•	•
210M,N,R, T210M,N,R, P210	•	•

## Rudder Pedal Shaft

P/N AD0411778-2  
FAA-PMA



**Half of Cessna Price!**

Aircraft Model
140A
150, 150A, F150, FA150
152, A152, F152, FA152
170, 170A, B
172, 172A,B,C,D,E,F,G,H,I,J,K,L,M,N,P
F172D,E,F,G,H,I,J,K,L,M,N,P
172RG, P172, R172E,F,G,H,K, FP172, FR172
175, 175A,B
180, 180A,B,C,D,E,F,G,H,J,K
182, 182A,B,C,D,E,F,G,H,I,K,L,M,N,P,Q,R
A182, F182, FR182, R182, TR182
185, 185A,B,C,D,E, A185E,F
190, 190A, 195, 195A,B
210-5 (205), 210-5A (205A)
206, U206, U206A,B,C,D,E
P206, P206A,B,C,D,E
207, T207
210, 210A,B,C,D,E,F,G,H,J,K, T210G,H,J

## Aileron Bellcrank Bushing

P/N MC0422280

- Use on all single engine Cessna
- High strength alloy steel
- Replace when replacing aileron cables
- 4 each included in all applicable Cessna cable kits



## Custom Fabricated Cables

DOD certified custom cable assemblies can be fabricated to specification MIL-DTL-6117, or certified to your special specifications

- Pre-stretched and proof loaded to MIL-DTL-5688
- Manufactured using the same materials and attention to quality as our FAA-PMA products. We cannot provide FAA-PMA approval for custom cables
- Pricing is based on material usage determined upon receipt of specifications or a pattern. Our sales team can provide a quote at that time
- One to three day service for most orders
- We are a DOD QML-6117 certified cable supplier

Download custom forms at <http://www.mcfarlaneaviation.com/services> or call to have one faxed.

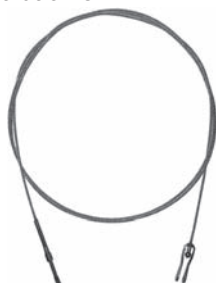

## Parking Brake Cables for Cessna Aircraft

Don't forget to replace worn out parking brake cables!

Locate your make, model and serial number on the flight control cable pages to find the correct part number for your aircraft.



FAA-PMA Approved

**Control Yoke Universal Joint with Protective Sleeve for Cessna Aircraft**

Save over 35%

P/N MC0411257

- Eliminates slack for precise and responsive control
- Replace worn or corroded joints
- Available separately or in a convenient kit including nuts and bolts

**Protective sleeve now included with every universal joint!**

Model
P/Ns MC0411257 and UJC-KT-2 are applicable to each aircraft model listed below
120, 140, 140A
150
150A,B,C,D,E,F,G,H,I,J,K,L,M
A150K,L,M,
F150F,G,H,I,J,K,L,M
FA150K,L,M, FRA150L,M
152, A152, F152, FA152
170, 170A,B,
172, 172A,B,C,D, F172D, FP172, P172D
172E,F,G,H,I,J,K,L,M,N,P,Q,R,S, T-41A
172RG, F172E,F,G,H,I,J,K,L,M,N,P
FR172E,F,G,H,I,J,K, R172K
R172E,F,G,H
175, 175A,B,C
180, 180A,B,C,D,E,F,G,H,I,K
182, 182A,B,C,D
185, 185A,B,C,D,E, A185E,F
210, 210A

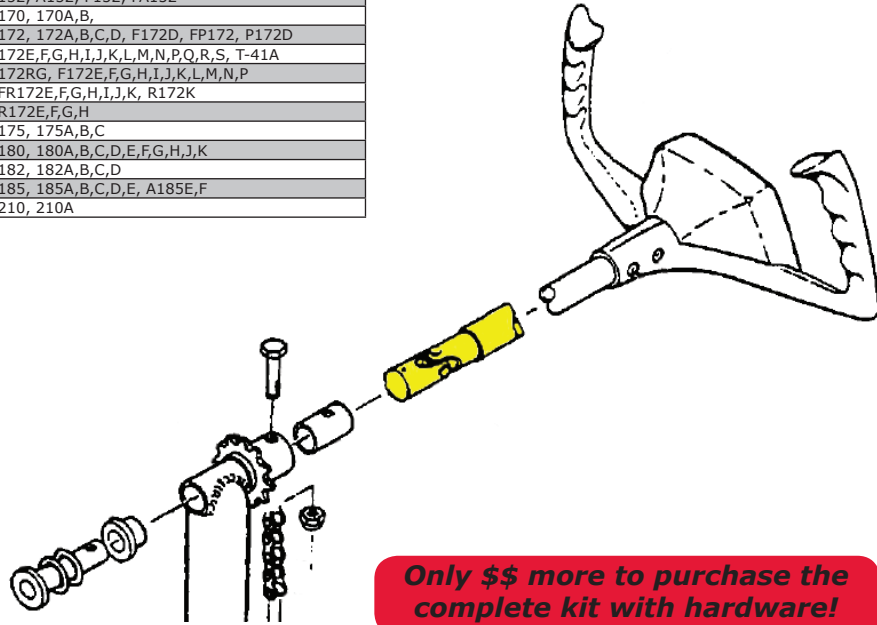

**Only \$\$ more to purchase the complete kit with hardware!**

P/N MC0411257  
Universal joint with protective sleeve



P/N UJC-KT-2  
Universal joint with protective sleeve and attaching hardware

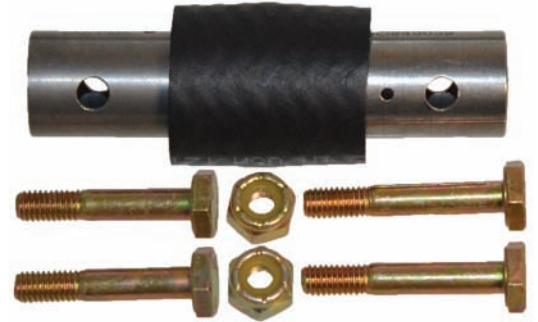

Kit P/N	Qty	Component	Description
UJC-KT-2	2	AN3-10A	Bolt
	2	AN3-11A	Bolt
	1	MC0411257	Universal Joint (w/sleeve P/N MC6183)
	2	MS21044N3	Nut

**Aileron Gap Kit for Cessna Aircraft**

Increase performance and safety!

P/N 115-100

Aircraft Development FAA-PMA/STC approved aileron gap seal kit includes aluminum strips to minimize air leakage between the rear wing spar and the aileron. Unlike most kits, this kit seals both the upper and lower gap for maximum aerodynamic effectiveness and efficiency. *This kit isn't a STOL kit, and don't expect miracles with any one of these improvements. However, the improvements are real and when all combined together result in a substantial improvement to your aircraft.*

**Increase Performance:**

- Reduced drag
- Increased lift
- Increased cruise speed
- Reduced stall speed
- Higher rate-of-climb
- Increased aileron authority
- Increased range (better fuel efficiency)

**Increase Safety:**

- Better spin resistance
- More aileron authority for crosswinds
- Reduced take-off and landing distances

Model
150 150A,B,C,D,E,F,G,H,I,J,K,L,M, A150K,L,M
152, A152
170B
172, 172A,B,C,D,E,F,G,H,I,J,K,L,M,N,P,Q,R,S
172RG, P172D, R172E,F,G,H,I,J,K
175, 175A,B,C
180, 180A,B,C,D,E,F,G,H,I,K
182, 182A,B,C,D,E,F,G,H,I,J,K,L,M,N,P,Q,R,S,T, T182, TR182, T182T
185, 185A,B,C,D,E, A185E,F
210-5 (205), 210-5A (205A)
210, 210A,B,C



P/N 115-100



Optional hardware kit includes enough rivets to install the aileron gap kit. P/N 115H

**Aileron with no seal**

High drag gap area and leak path from high pressure underside of wing to low pressure top side of wing.

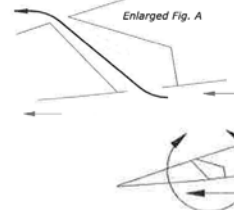

**Aileron with seal**

Gap seals reduce drag and air leaks.

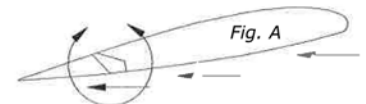
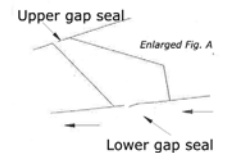

Manufactured by Aircraft Development

## Control Yoke Universal Joint Kits for Piper Aircraft Helps comply with AD 2010-15-10

**Save over 60% off Piper price. Just our reamer saves you \$100!**

- Individual parts also available separately
- Hardened stainless steel - Nitrided wear surfaces
- Eliminates free motion for precise and responsive control
- Replace worn or corroded joints

AD 2010-15-10 and Piper service bulletin 1197C requires inspection of the connection between the control yoke u-joint and the shaft on the forward (engine) end of the joint. This inspection is a convenient time to replace worn out u-joints. McFarlane has kits including the u-joint, shaft, taper pins, taper reamer, drill bit and other hardware to help comply with this AD, all at a fraction of the cost of buying the parts from Piper.



Universal Joint Kits for Piper Aircraft			
Model	Serial Number	Left (Pilot)	Right (Copilot)
PA-28-140	28-20001 thru 28-20160	UJP-KT-3 or 3T	UJP-KT-5 or 5T
	28-20161 thru 28-21845	UJP-KT-4 or 4T	UJP-KT-5 or 5T
	28-21846 thru 28-21930	UJP-KT-1 or 1T	UJP-KT-2 or 2T
	28-21931 thru 28-21934	UJP-KT-4 or 4T	UJP-KT-5 or 5T
	28-21935 thru 28-25400	UJP-KT-1 or 1T	UJP-KT-2 or 2T
	28-25401 thru 28-7725290	UJP-KT-2 or 2T	UJP-KT-2 or 2T
PA-28-150	28-1 thru 28-1760, 28-03, 28-1760A	UJP-KT-3 or 3T	UJP-KT-5 or 5T
	28-1761 thru 28-3377	UJP-KT-4 or 4T	UJP-KT-5 or 5T
	28-3378 thru 28-4377	UJP-KT-1 or 1T	UJP-KT-2 or 2T
PA-28-151	All	UJP-KT-2 or 2T	UJP-KT-2 or 2T
PA-28-160	28-1 thru 28-1760, 28-03, 28-1760A	UJP-KT-3 or 3T	UJP-KT-5 or 5T
	28-1761 thru 28-3377	UJP-KT-4 or 4T	UJP-KT-5 or 5T
PA-28-161	All	UJP-KT-1 or 1T	UJP-KT-2 or 2T
	28-671 thru 28-1760, 28-03	UJP-KT-3 or 3T	UJP-KT-5 or 5T
PA-28-180	28-1761 thru 28-3377	UJP-KT-4 or 4T	UJP-KT-5 or 5T
	28-3378 thru 28-4377	UJP-KT-1 or 1T	UJP-KT-2 or 2T
	28-4378 thru 28-7505260, 28-E13	UJP-KT-2 or 2T	UJP-KT-2 or 2T
PA-28-181	All	UJP-KT-2 or 2T	UJP-KT-2 or 2T
PA-28-201T	All	UJP-KT-2 or 2T	UJP-KT-2 or 2T
PA-28-235	28-10001 thru 28-10486	UJP-KT-3 or 3T	UJP-KT-5 or 5T
	28-10487 thru 28-10719	UJP-KT-4 or 4T	UJP-KT-5 or 5T
	28-10720 thru 28-11039	UJP-KT-1 or 1T	UJP-KT-2 or 2T
	28-11040 thru 28-7710089, 28E-11	UJP-KT-2 or 2T	UJP-KT-2 or 2T
PA-28-236	All	UJP-KT-2 or 2T	UJP-KT-2 or 2T
PA-28R-180	All	UJP-KT-2 or 2T	UJP-KT-2 or 2T
PA-28R-200,201	All	UJP-KT-2 or 2T	UJP-KT-2 or 2T
PA-28R-201T	All	UJP-KT-2 or 2T	UJP-KT-2 or 2T
PA-28RT-201	All	UJP-KT-2 or 2T	UJP-KT-2 or 2T
PA-28RT-201T	All	UJP-KT-2 or 2T	UJP-KT-2 or 2T
PA-28S-160	28-1 thru 28-1760, 28-1760A	UJP-KT-3 or 3T	UJP-KT-5 or 5T
	28-671 thru 28-1760	UJP-KT-3 or 3T	UJP-KT-5 or 5T
	28-1761 thru 28-3377	UJP-KT-4 or 4T	UJP-KT-5 or 5T
	28-3378 thru 28-4377	UJP-KT-1 or 1T	UJP-KT-2 or 2T
PA-28S-180	28-4378 thru 28-7105234	UJP-KT-2 or 2T	UJP-KT-2 or 2T
	32-1 thru 32-600, 32-03, 32-04	UJP-KT-4 or 4T	UJP-KT-5 or 5T
	32-601 thru 32-690	UJP-KT-1 or 1T	UJP-KT-2 or 2T
	32-691 thru 32-7800008	UJP-KT-2 or 2T	UJP-KT-2 or 2T
PA-32-300	32-15, 32-21	UJP-KT-4 or 4T	UJP-KT-5 or 5T
	32-40000 thru 32-40415	UJP-KT-1 or 1T	UJP-KT-2 or 2T
	32-40416 thru 32-7940290	UJP-KT-2 or 2T	UJP-KT-2 or 2T
PA-32-301	All	UJP-KT-2 or 2T	UJP-KT-2 or 2T
PA-32-301T	All	UJP-KT-2 or 2T	UJP-KT-2 or 2T
PA-32R-300	All	UJP-KT-2 or 2T	UJP-KT-2 or 2T
PA-32R-301,301T	All	UJP-KT-2 or 2T	UJP-KT-2 or 2T
PA-32RT-300	All	UJP-KT-2 or 2T	UJP-KT-2 or 2T
PA-32RT-300T	All	UJP-KT-2 or 2T	UJP-KT-2 or 2T
PA-32S-300	32S-15	UJP-KT-4 or 4T	UJP-KT-5 or 5T
	32S-40000 thru 32S-40415	UJP-KT-1 or 1T	UJP-KT-2 or 2T
	32S-40416 thru 32S-7240137	UJP-KT-2 or 2T	UJP-KT-2 or 2T
PA-34-200,200T	All	UJP-KT-2 or 2T	UJP-KT-2 or 2T
PA-34-220T	All	UJP-KT-2 or 2T	UJP-KT-2 or 2T
PA-44-180,180T	All	UJP-KT-2 or 2T	UJP-KT-2 or 2T

Partial model eligibility

Part Number	Description	Qty
<b>UJP-KT-1</b>		
CA62834-802SS	Universal Joint	1
62716-006	Shaft	1
AN386-1-6A	Taper Pin	2
NAS1149F0363P	Washer	2
AN975-3	Washer	2
404-526	Nut	2
404-156	Nut	2
<b>UJP-KT-1T</b>		
UJP-KT-1	See above	1
6532	Taper Reamer	1
6533	#5 Drill Bit	1
<b>UJP-KT-2</b>		
CA62834-802SS	Universal Joint	1
62716-007	Shaft	1
AN386-1-6A	Taper Pin	2
NAS1149F0363P	Washer	2
AN975-3	Washer	2
404-526	Nut	2
404-156	Nut	2
<b>UJP-KT-2T</b>		
UJP-KT-2	See above	1
6532	Taper Reamer	1
6533	#5 Drill Bit	1
<b>UJP-KT-3</b>		
CA62834-000SS	Universal Joint	1
AN386-1-6A	Taper Pin	2
NAS1149F0363P	Washer	2
AN975-3	Washer	2
404-526	Nut	2
404-156	Nut	2
<b>UJP-KT-3T</b>		
UJP-KT-3	See above	1
6532	Taper Reamer	1
6533	#5 Drill Bit	1

Shaft P/N 62716-002 is no longer available and has been removed from this kit.

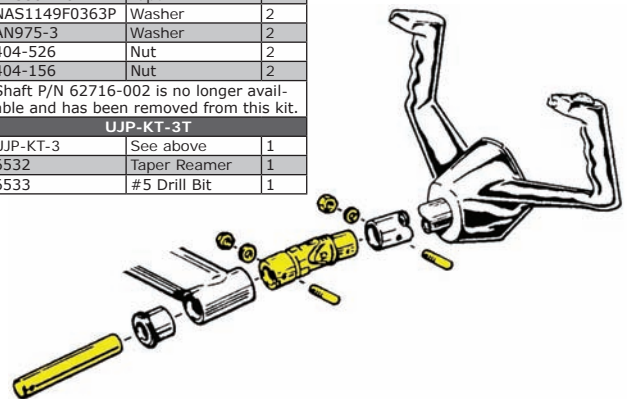

### Maintenance Tip:

*How do I know if my universal joint needs to be replaced?*

A universal joint attaches to each control yoke shaft behind the instrument panel. Replacement of the universal joint is required if any free motion or rust around the joint pivots is detected or if the joint fails inspection required by AD 2010-15-10.

*What can I do if I cannot separate the shaft from the universal joint?*

We can help! McFarlane offers a service to remove stuck shafts. Call for details.

## U-Joint Taper Pin Removal Tool

Part number TOOL107

- Save time and money.
- Makes removal of stuck pins easy.
- Prevents damage from hammering behind the panel.
- Compact to get in tight places.
- Heat treated 4140 Alloy Steel.



## Witness Hole Drill Fixture

Piper part number 766-585

A convenient tool for older universal joints that don't have a witness hole. Use to drill a witness hole in Piper universal joints per Piper service bulletin 1197C.

Saves time! Avoids disassembly of U-joint and shaft.



FAA-PMA Approved

**Stabilator Trim Kits for Piper Aircraft**

Save time and money with convenient kits!

- Shafts and barrels manufactured by PMA Products, Inc.
- Bearing manufactured by Piper

Model	Part Number
PA28-140, 150, 151, 160, 161, 180, 181	PSTAB-KT-1
PA28-235, 236	PSTAB-KT-1
PA28-201T S/N 28-7921001 to 28-7921095	PSTAB-KT-1
PA28R-180, 200, 201, 201T	PSTAB-KT-1
PA32, PA32R	PSTAB-KT-1
PA34-200 S/N 34-7350185 and up	PSTAB-KT-2
PA34-200T, PA34-220T	PSTAB-KT-2
<b>PSTAB-KT-1 Contains</b>	
(1) CA65246-100 Trim Shaft (includes instructions and STC)	
(1) CA63530-100 Trim Barrel (includes instructions and STC)	
(2) 452-413 Bearing	
<b>PSTAB-KT-2 Contains</b>	
(1) CA65246-002 Trim Shaft	
(1) CA96596-002 Trim Barrel	
(2) 452-413 Bearing	

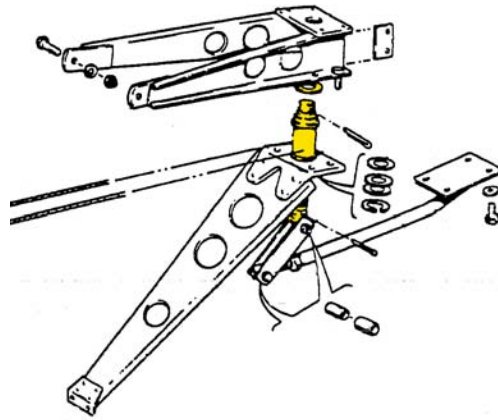

**Maintenance Tip:**  
When replacing the stabilator trim barrel, it is normally a good time to also replace the stabilator trim cables. See pages 112-116 to find the correct cable(s) for your aircraft.

**Note:** Some trim barrels supplied by Piper were incorrectly manufactured and must be replaced. See Piper SB1251 or later revised service bulletin for more details. This service bulletin is not applicable to P/N CA63530-100 manufactured by PMA Products, Inc., however P/N CA63530-100 may be used to replace trim barrels affected by the service bulletin.

**Trim Wheel Shafts and Sprockets for Cessna Aircraft**

Elevator trim shaft and sprocket for most 172 thru 185 and early 210 models.

Rudder trim sprocket for many 182, 205, 206, 207 models.

Aileron trim sprocket for Caravan 208 and 208B aircraft.

- Stainless Steel
- Heat treated shafts for extra strength
- Resists roll pin hole wear
- Roll pins in stock - P/N MS16562-25 (qty: 2 required per shaft)

Aircraft Model	Part Number				
	MC0432134-1 Sprocket	MC0761210-1 Sprocket	MC0713656-3 Trim Wheel Shaft	MC0761205-2 Trim Wheel Shaft	MC0761205-9 Trim Wheel Shaft
120, 140, 140A	•				
150, 150A,B,C,D,E,F,G,H,J,K,L,M, A150K,L,M, F150F,G,H,J,K,L,M, FA150K,L,M	•				
152, A152, F152, FA152	•				
170, 170A,B	•				
172, 172A,B,C,D,E, F172D,E, FP172, P172	•				
172F,G,H,I,J,K,L,M,N,P,Q,R,S, 172RG, F172F,G,H,K,L,M,N,P, FR172E,F,G,H,J,K, R172E,F,G,H,K	•		•		
175, 175A,B,C	•				
177, 177A,B, 177RG, F177RG	•				
180, 180A,B,C,D,E,F,G,H	•				
180H,I,K	•				•
182, 182A,B,C,D	•				•
182E,F,G,H,J,K,L,M,N,P,Q,R,S,T	•	• 1			
F182P,Q	•	• 1			
FR182	•	•			
R182	•	• 1			
T182	•	• 1			
T182T	•	• 1			
TR182	•	• 1			
185, 185A,B,C,D,E, A185E	•				
A185F	•				
188, 188A,B, A188, A188A,B 188B (w/large hopper), T188C	•				
210-5 (205), 210-5A (205A)	•	• 1			
206, 206H, T206H, U206, U206A,B,C,D,E,F,G, TU206A,B,C,D,E,F,G, P206, P206A,B,C,D,E, TP206A,B,C,D,E	•	• 1			
207, 207A, T207, T207A	•	• 1			
208B	•	• 2			
210, 210A	•				•

**Notes:**  
All eligibility shown is for elevator/stabilizer/stabilator trim system except where noted.  
1 Used in rudder trim system  
2 Used in aileron trim system

**Improved Design!**

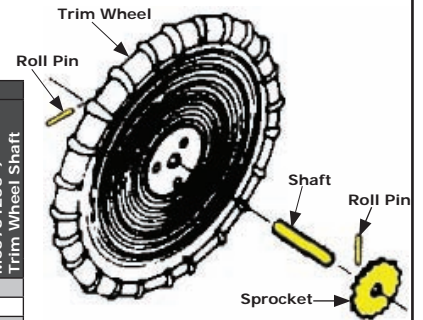

**Save!**



Flight Control System

## Trim Actuator for Cessna Aircraft



### FAA-PMA P/N MC1260074-1

- Greatly improved design
- Half the price

McFarlane Aviation has developed a direct replacement trim jack actuator that incorporates many design improvements. Stronger metals and longer lasting coatings are utilized for increased service life and smoother operation with improved corrosion resistance.

The Screw Assembly is manufactured using high strength stainless steel alloy that has been nitro-carburized for maximum wear, low friction, smoother thread operation, and greatly improved corrosion protection over the OEM part. The sprocket is manufactured using a stronger aluminum and is anodized to keep the surface protected from wear and corrosion.

McFarlane's precision machining significantly reduces the unwanted play found in OEM assemblies. The known problems of original parts have been addressed and resolved with McFarlane's new design!

Trim Jack Actuator P/N MC1260074-1	
Aircraft	Location
120, 140, 140A	Elevator
150, 150A,B,C,D,E,F,G,H,I,K,L,M, A150K,L,M, F150F,G,H,J,K,L,M, FA150K,L,M, FRA150L,M	Elevator
152, A152, F152, FA152	Elevator
170, 170A,B	Elevator
172, 172A,B,C,D,E,F,G,H,I,K,L,M,N,P,Q,R,S, 172RG, F172D,E,F,G,H,K,L,M,N,P, FP172, FR172E,F,G,H,J,K, P172D, R172E,F,G,H,K	Elevator
175, 175A,B,C	Elevator
182E,F,G,H,J,K,L,M,N,P,Q,R,S,T, F182P,Q, FR182, R182, T182, T182T, TR182	Elevator
188, 188A,B, A188, A188A, A188B Includes with large hopper, T188C	Elevator
190, 195, 195A,B	Elevator
210-5 (205), 210-5A (205A)	Elevator
206, P206, P206A,B,C,D,E, TP206A,B,C,D,E, TU206A,B,C,D,E,F, U206, U206A,B,C,D,E,F	Elevator
207, T207 <sup>1</sup>	Elevator
210, 210A,B,C,D,E,F,G,H,J,K,L <sup>2</sup> , T210F,G,H,J,K,L <sup>2</sup>	Elevator
310, 310B,C,D,F,G,H,I,J, J-1, E310H,J	Elevator & Aileron
310K <sup>3</sup>	Elevator & Aileron
	Elevator
310P,Q,R, T310P,Q,R <sup>4</sup>	Elevator
320, 320-1, 320A,B,C,D	Elevator & Aileron
320E <sup>5</sup>	Aileron
411, 411A	Elevator
Notes:	
<sup>1</sup> S/N 20700001 thru 20700227	
<sup>2</sup> S/N 57001 thru 21060089	
<sup>3</sup> S/N 310K0001, 310K0046 thru 310K0245	
<sup>4</sup> S/N 310P0001 thru 310R1500	
<sup>5</sup> S/N 320E0001	

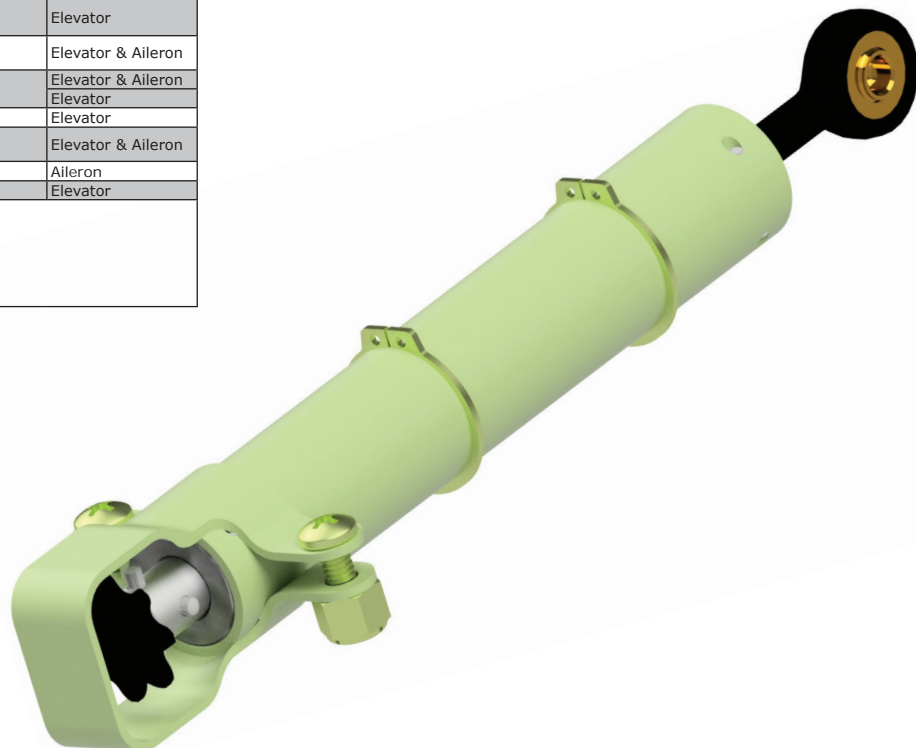

FAA-PMA Approved

**Trim Wheel Stop Catch Assembly for Cessna Aircraft**

Save more than 75%

- FAA-PMA direct replacement
- Improved durable button for extended life
- 2 required per aircraft

P/N	Aircraft
MC0713023-3	180, 180A,B,C,D,E,F
MC0713827-1	180G,H,J,K
MC0713023-3	182, 182A,B,C,D
MC0713023-3	185, 185A,B
MC0713827-1	185C,D,E, A185E,F

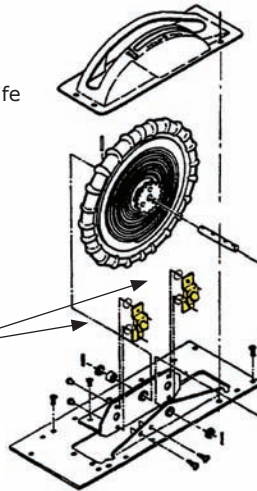

Trim wheel stop catch



Longer Service Life!

**Maintenance Tip:**

*If you notice mild creep in the trim system this is often caused by worn out trim wheel stop catches. McFarlane offers improved stop catches at a fraction of the cost from the originals.*

**Stabilizer Jack Screw Pin Tool for Cessna 180, 182 and 185 Aircraft**

P/N TOOL131

- For Cessna 180, 182, 185 jack screws
- Easily and safely remove and install your roll pin with the turn of a wrench
- No more damaging your jack screw by using a punch and hammer
- Manufactured with hardened stainless steel for increased tool life
- Works only with the larger McFarlane pin sold with P/N 1111



**Avoid Costly Damage!**

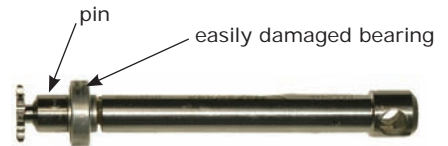

**Stabilizer Jack Screw Actuator Kit for Cessna 180, 182 and 185 Aircraft**

**Improved Material for Extreme Corrosion Resistance**

McFarlane replaces the original steel components with duplex stainless steel (even better than Monel) components for a long life even in a harsh saltwater environment.

**Improved Bearing**

Precision bearing reduces free play and features extra low temperature grease for easy turning at low temperatures.

**Improved Strength and Reliability**

The original Cessna actuators use a 3/32" roll pin to attach the sprockets and retaining collars to the screw bars. These pins are critical as the front of the stabilizer would detach from the airframe if they failed. Although the original roll pins are technically strong enough, the original design is marginal in strength. To provide a more robust design, McFarlane redesigned the sprocket and retaining collar to allow the use of a 5/32" roll pin. This more than doubles the strength of the design. The screw and barrel are match machined for a precision fit.

**Convenient Kit**

Stabilizer jack-screw kit P/N 1111 is an FAA-PMA/STC approved kit to replace all wear components for the stabilizer actuator assemblies for many Cessna 180, 180A-K, 182, 182A-D, 185, 185A-E, A185E-F aircraft. P/N 1111 includes all parts required to replace the following Cessna parts in both the left-hand and right-hand actuators:

- 0310332 Sprocket
- 0712500-11 Screw-Bar
- 0712500-13 Barrel
- 0712500-7 Collar-Retainer
- 0712502 Bushing Eccentric
- 0712500-10 Bushing
- MS20201KP6A or AN201KP6A Bearing
- NAS561-3-8 Roll Pin
- 0432138-3 or S2295-25-185 Chain
- 0712500-19 Plug

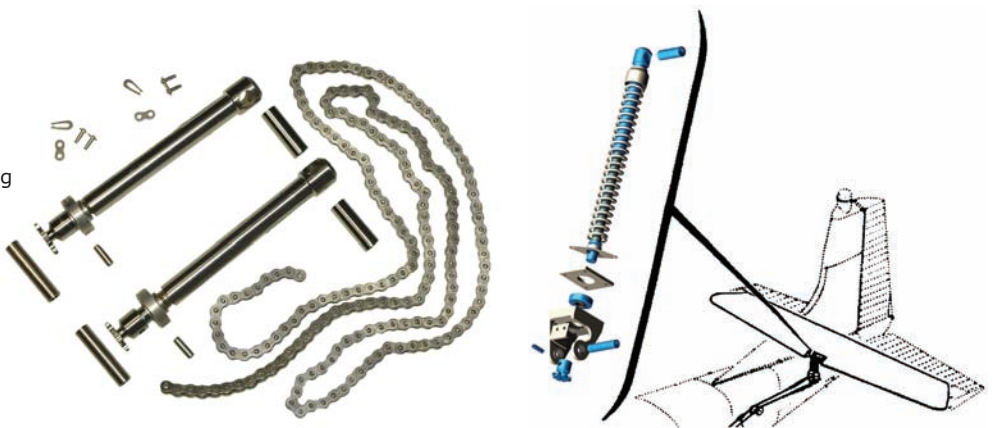

**Replacement Components**

P/N 1111 contains the following replacement components:

- 6361 Stainless Steel Roller Chain
- 6464 Connecting Link
- 6458 Eccentric Upper Bushing
- 6459 Lower Bushing
- 6460 Bearing
- 6461 Spring Pin (can only be used as a replacement with McFarlane P/N 1111)

**Trim Actuator Boot and Clamp**

Now FAA-PMA approved and manufactured by McFarlane!

Boot P/N MC0712500-18 and Clamp P/N MC7137.

- Fits all 180, 180A-K, 182, 182A-D, 185, 185A-E, A185E-F aircraft
- McFarlane recommends replacing the boot and clamp at the same time
- High quality, flexible, durable, long life material

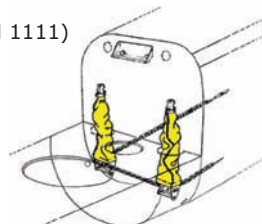

**Maintenance Tip:**

*If the stabilizer is sluggish or jams, clean the barrel and screw jack and re-apply a coating of MIL-PRF-23827 low temperature grease. Complete instructions can be found at [www.mcfarlaneaviation.com/ICA](http://www.mcfarlaneaviation.com/ICA)*